

ESBE CRx200



Series CRA200
Series CRB200
Series CRC200

Series CRD200
Series CRK200
Series CRS200

LVD 2014/35/EU
EMC 2014/30/EU
RoHS 2011/65/EU
RED 2014/53/EU
EN 300220-2

CE EAC



DECLARATION OF CONFORMITY
<https://www.esbe.eu/group/support> (Contorlers/Certificates)

i



Series CRA210
Series CRB210, CRB220
Series CRC210
Series CRD220,
Series CRK210
Series CRS210



VRG, VRB

VRH

BIV



3F, 4F ≤ DN50

T

HG



3G, 4G

TM

VRC160

H

3MG, 4MG

i

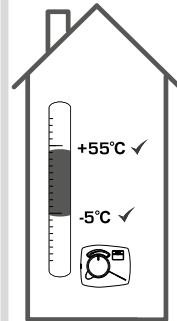

1

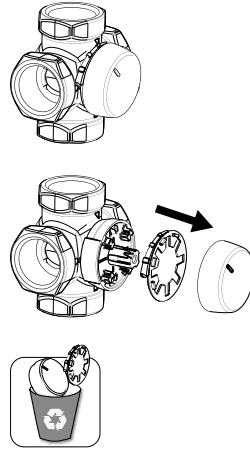

2



IP44 POSITION

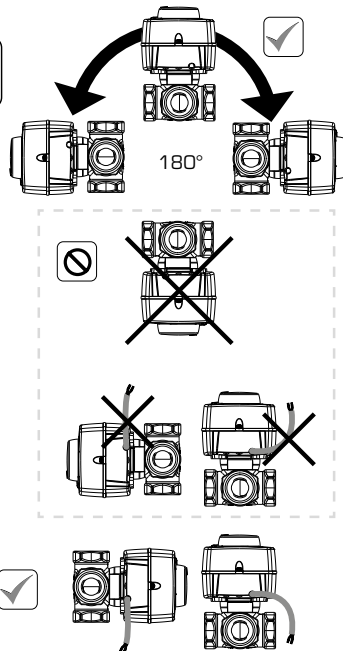

3



Series MG, G, F, H, HG, BIV, T, TM

	DN15-25	
	DN20-40	
	DN50	
	DN20-25	
	DN32-50	
	H: DN25	
	H: DN32-50	
	HG: DN25	
	DN20-22	
	DN25	
	T: DN20-32	
	TM: DN20	

Kit	*Parts
	*1
	*2
	*3

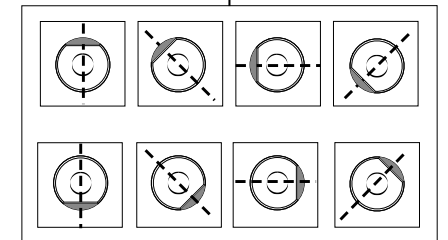
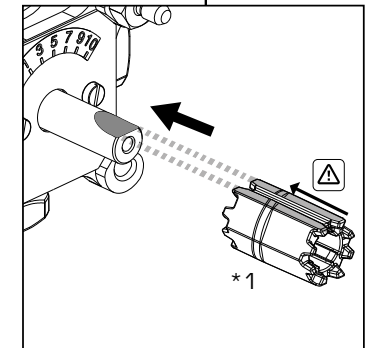
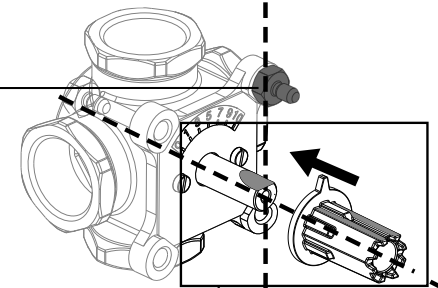

Series VRGxxx, VRBxxx, VRHxxx

Series VRCxxx

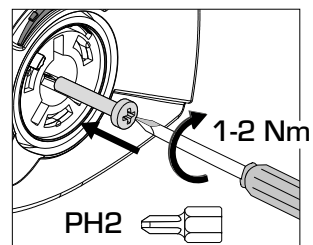
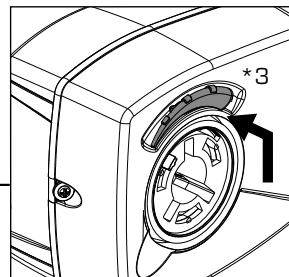
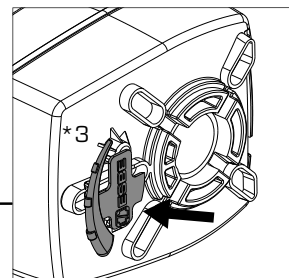
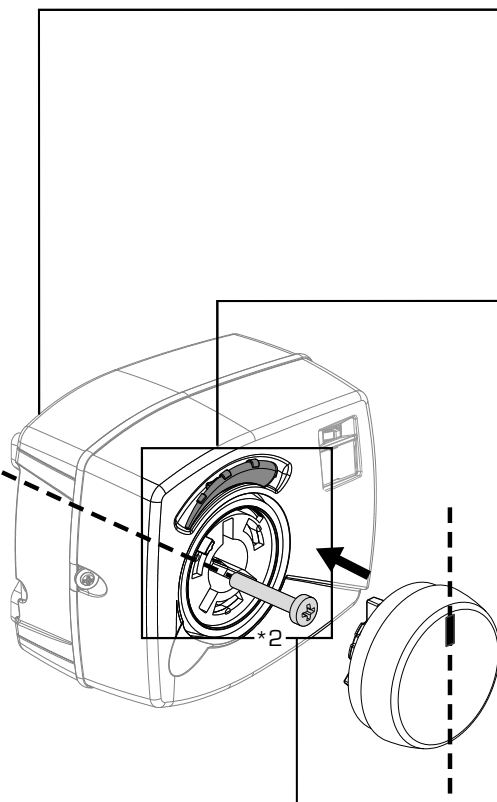
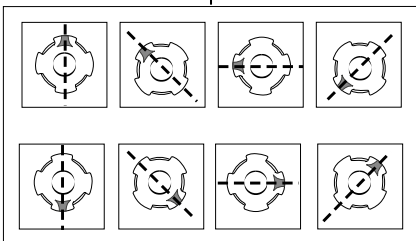
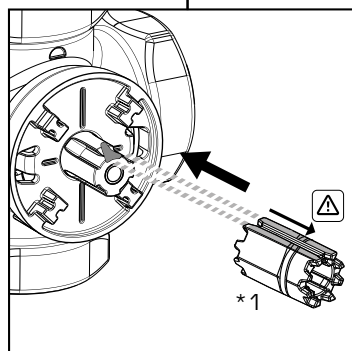
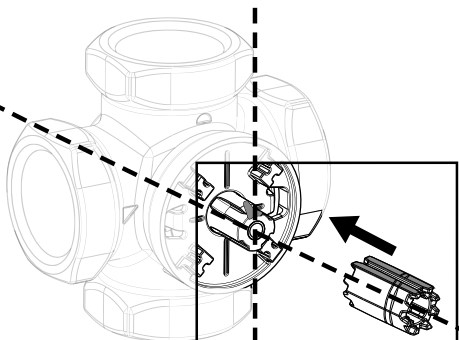

ESBE AB
Bruksgatan 22
SE-333 75 Reftele
www.esbe.eu



Mtrl.nnr: 98141094 Rit.nnr: 9326 vers. B • Rev. 2025-01-14



**SERIES CRx
Assembly**



<https://esbe.eu/group/lp/crx-manual>

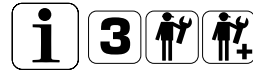

SERIES VRG130

a

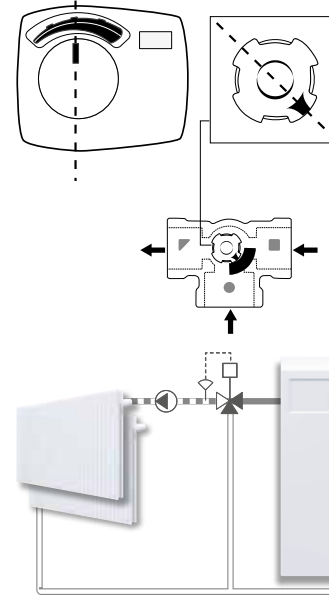

b

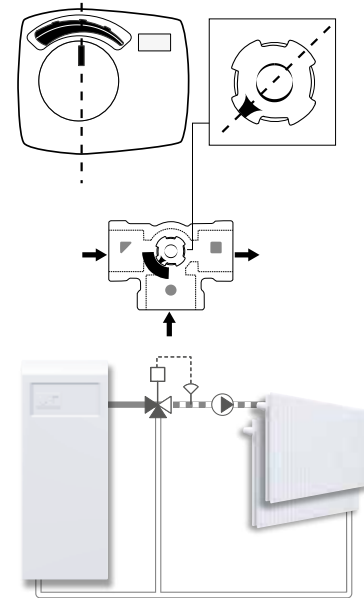

h

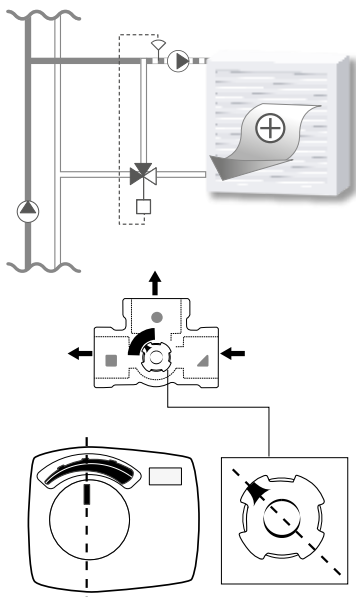

i

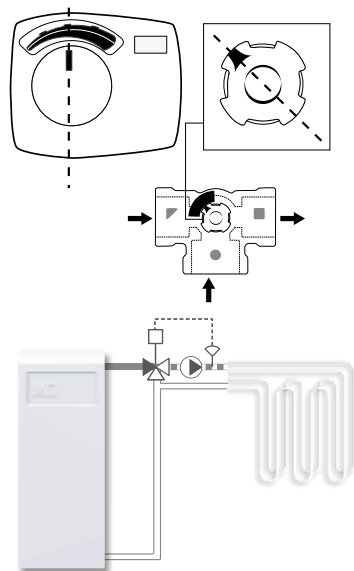

j

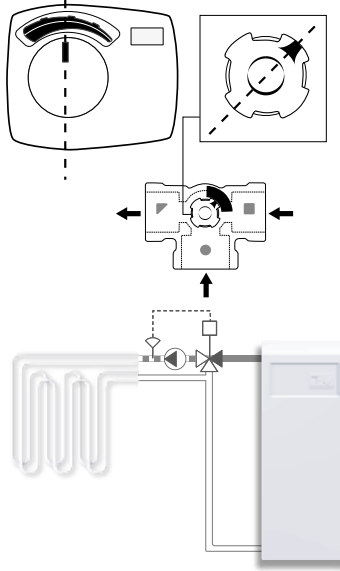

k

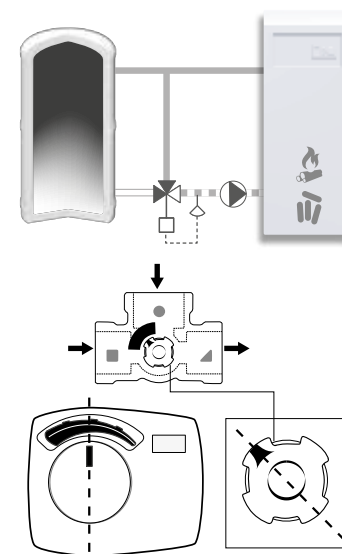

l

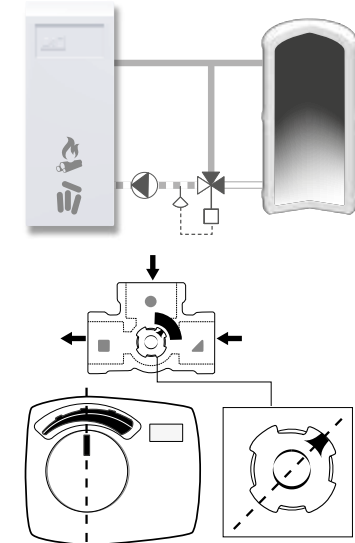

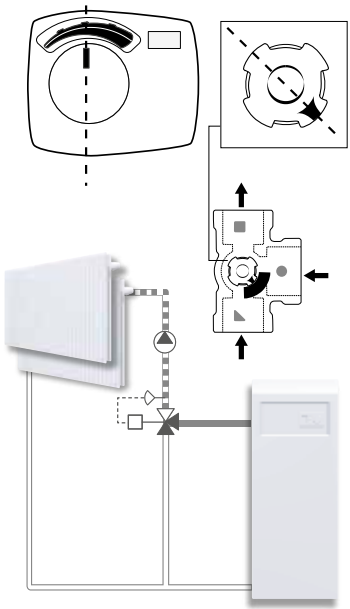
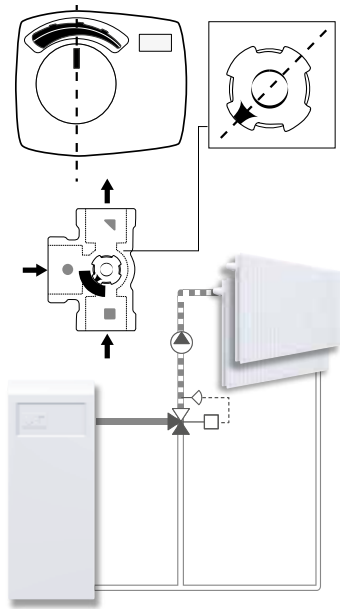
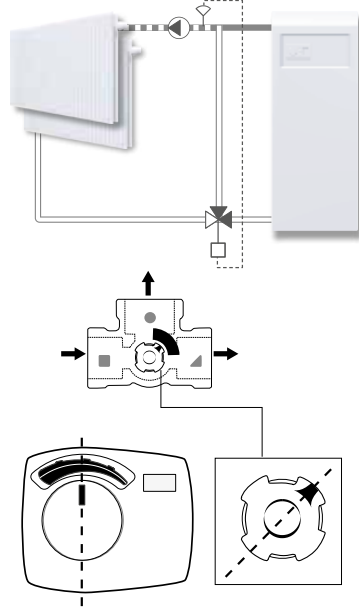
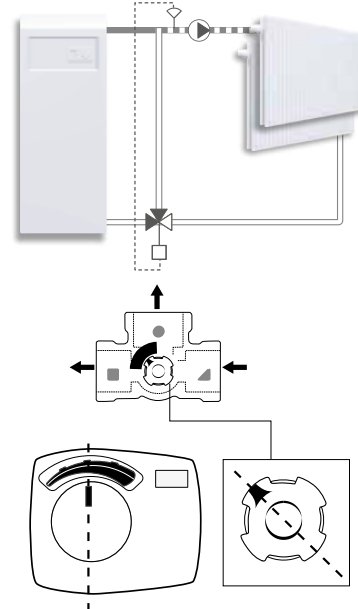
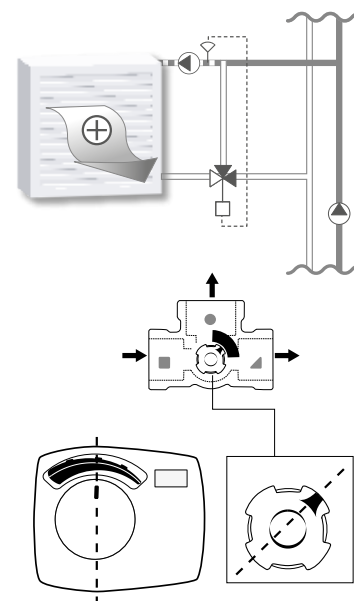
c**d****e****f****g**

SERIES VRG130

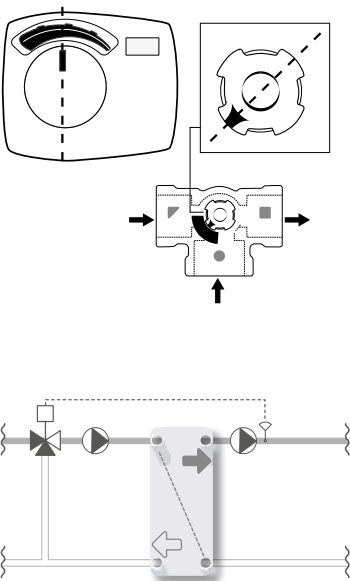
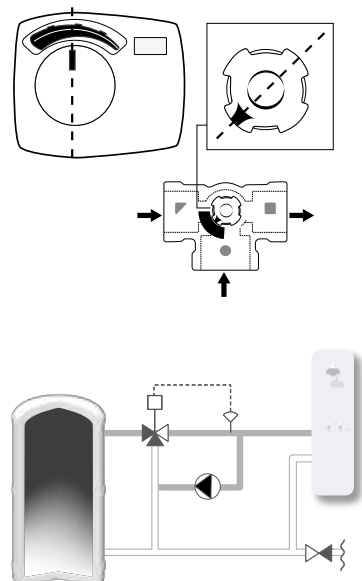
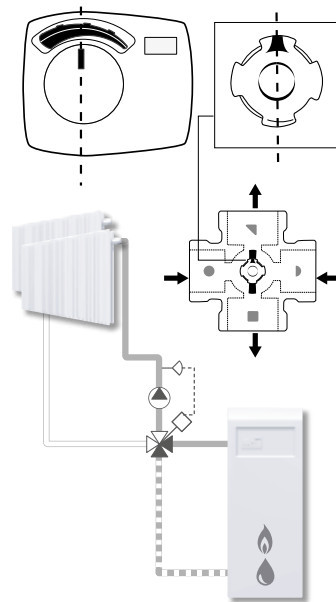
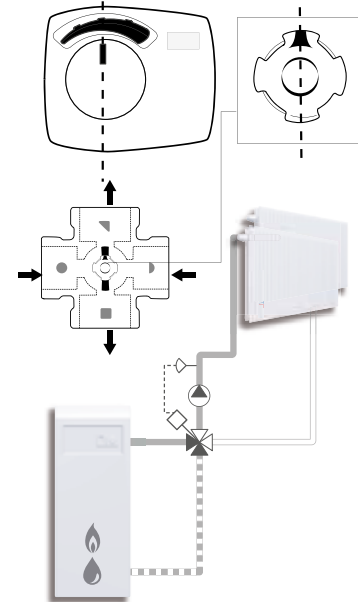
m**n****SERIES VRG140****a****b**

SERIES VRG230

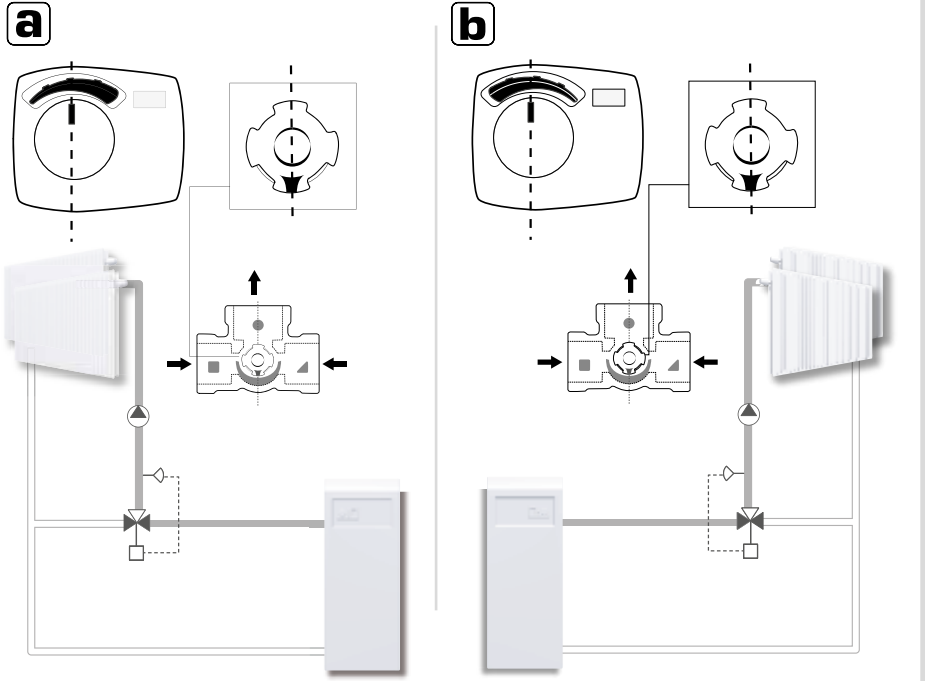

SERIES VRG330

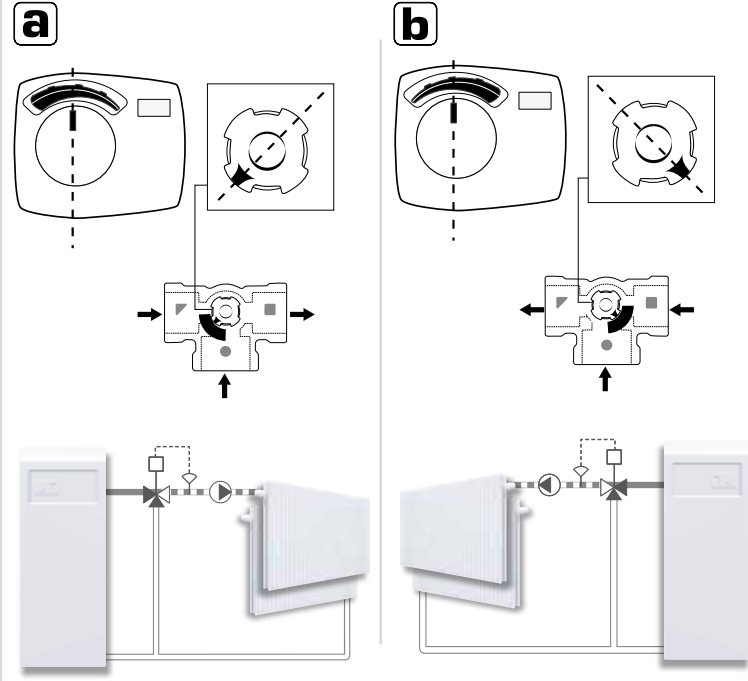

SERIES VRB140

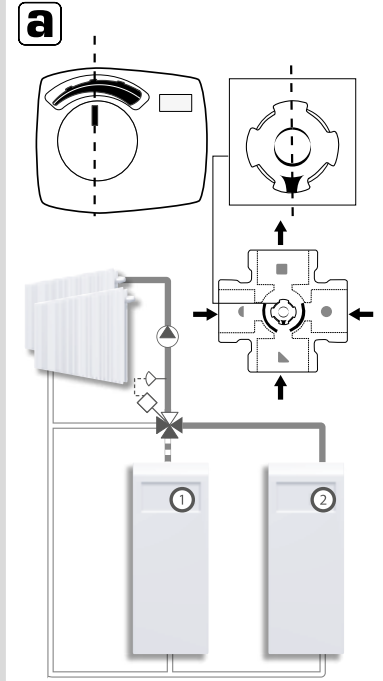

SERIES BIV

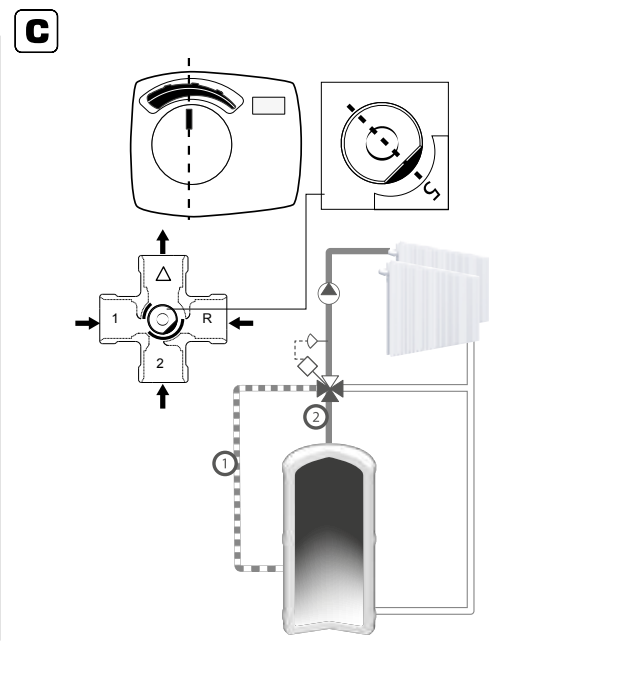
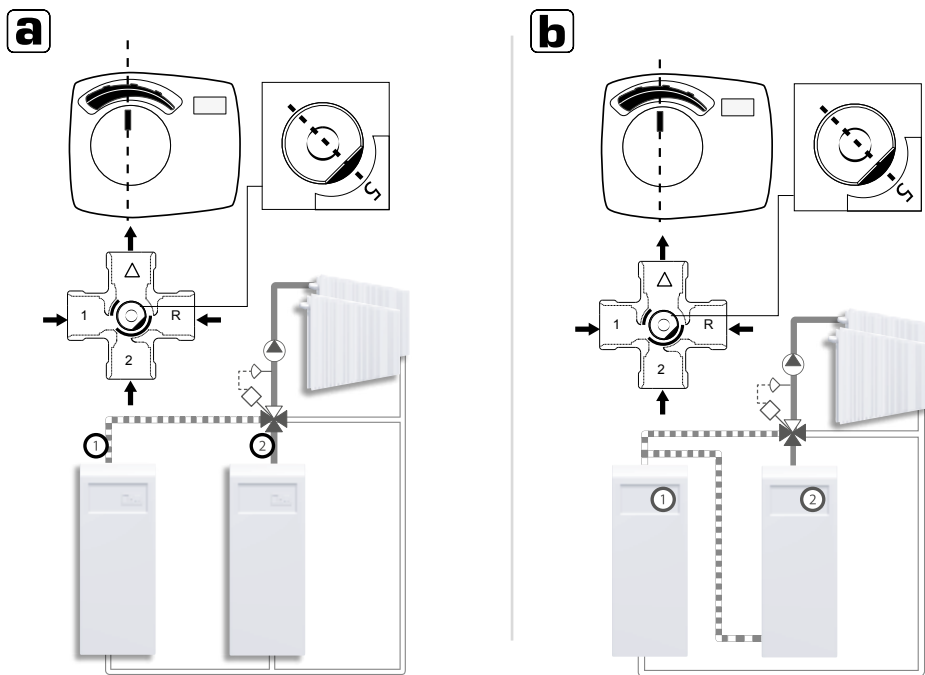

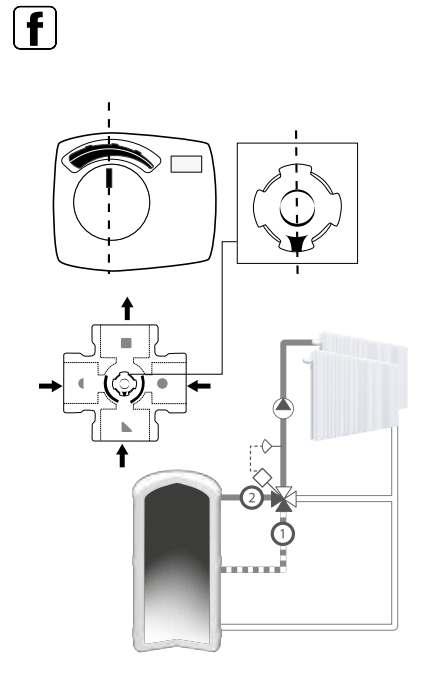
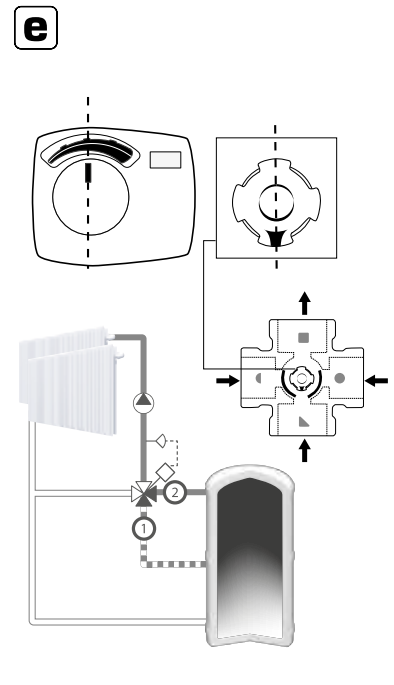
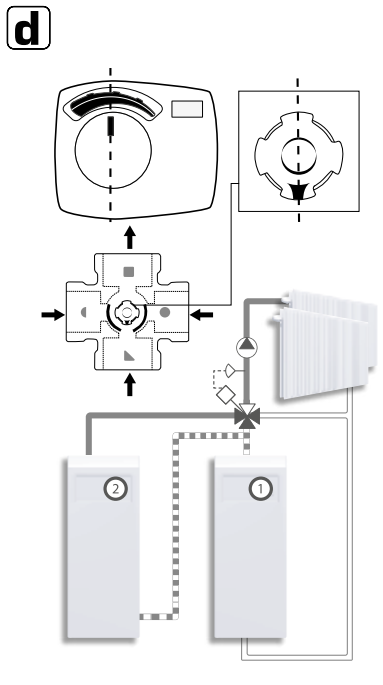
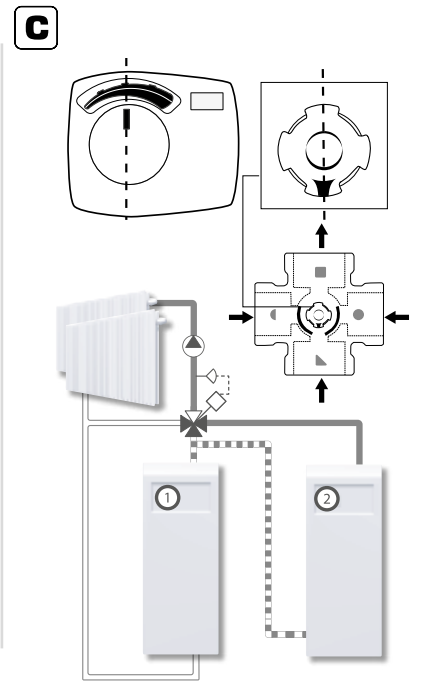
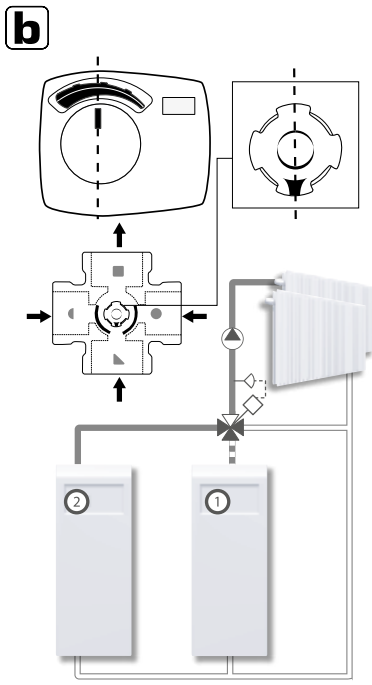

SERIES VRB140

SERIES 4F, 4MG, 4G

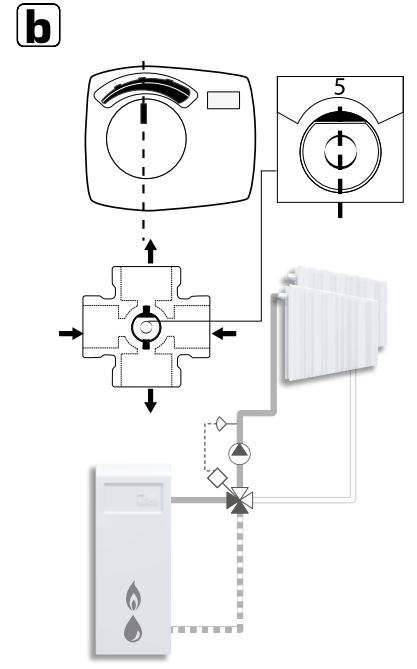
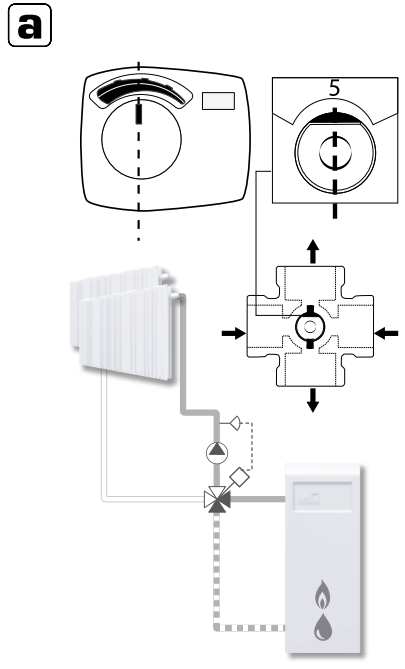

PUMP CONTROL

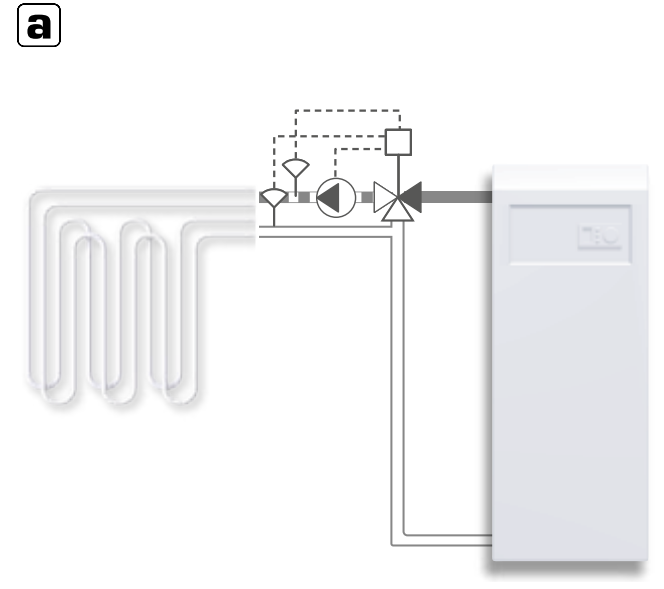

Piping Schematics are General Representations

SERIES 3F, 3MG, 3G

a

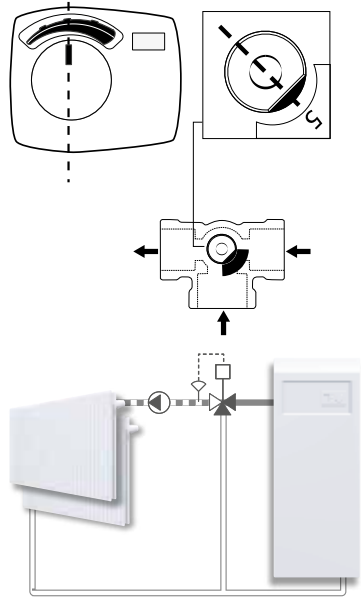

b

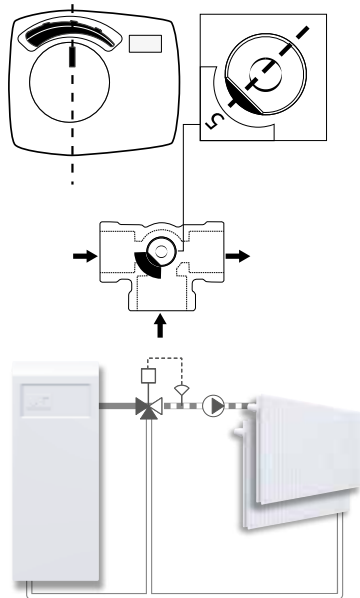

c

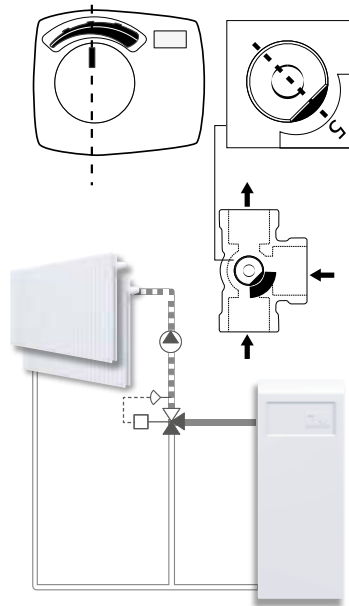

d

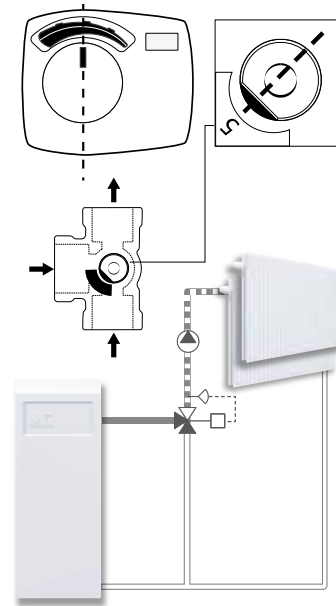

e

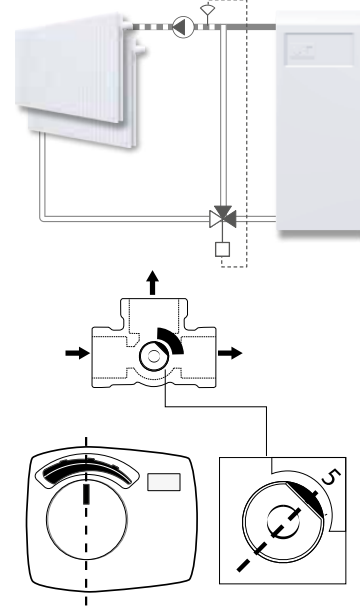

k

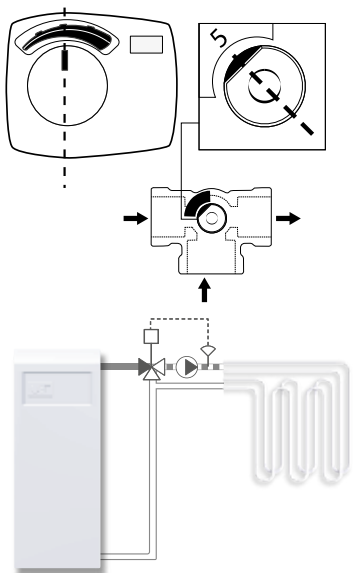

l

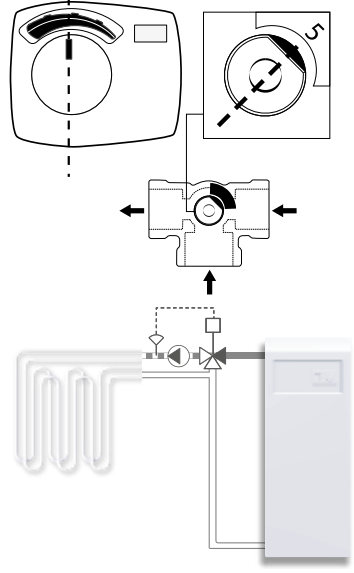

m

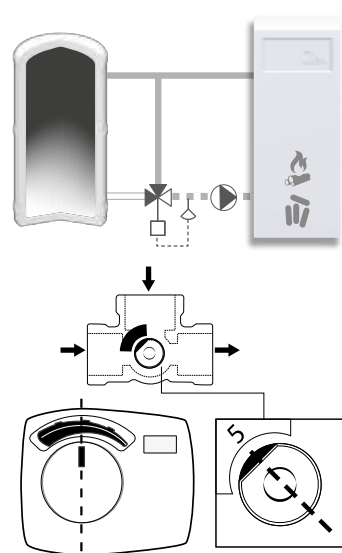

n

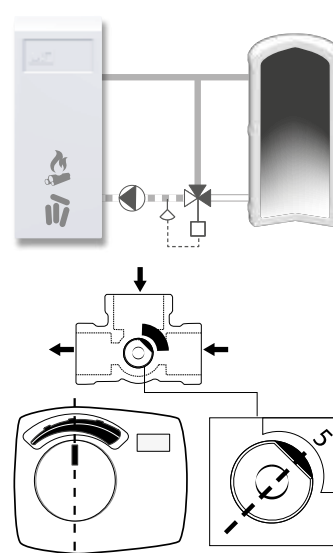

o

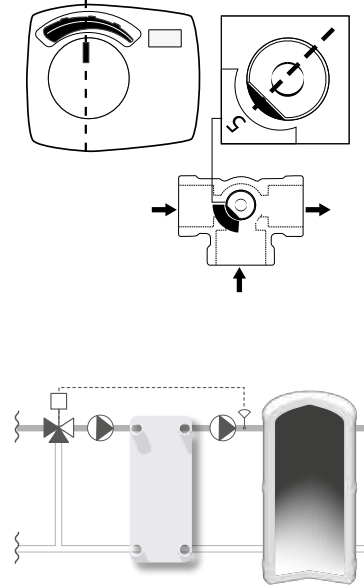

f

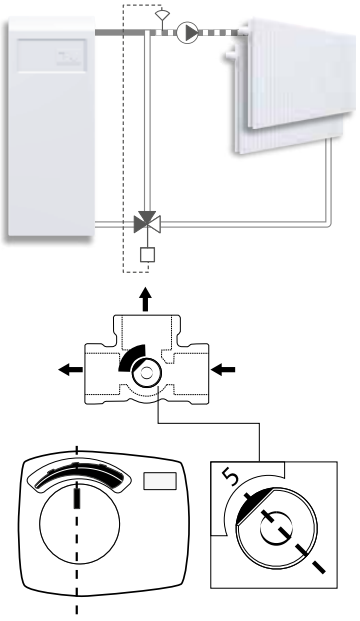

g

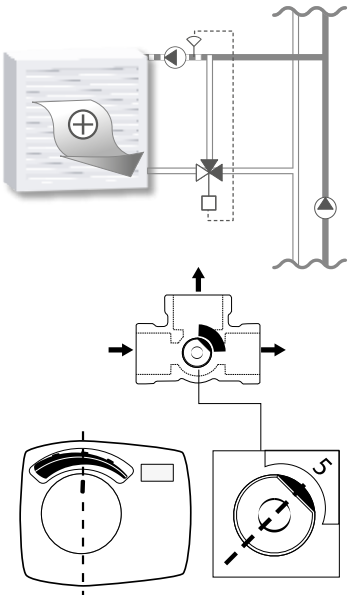

h

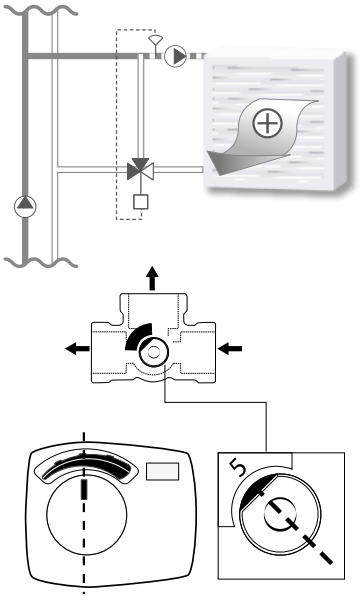

i

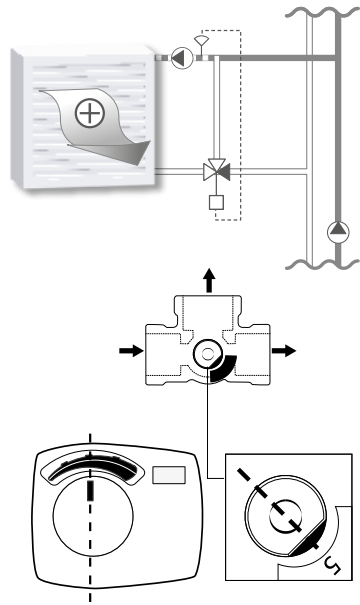

j

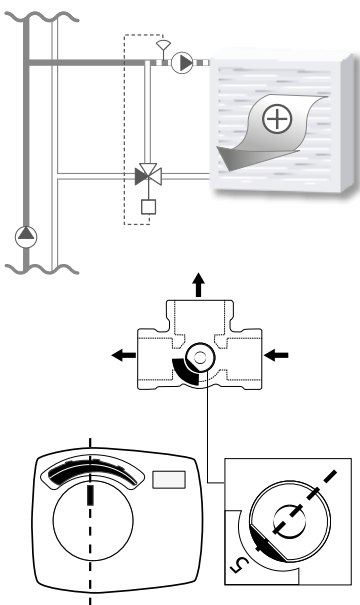

p

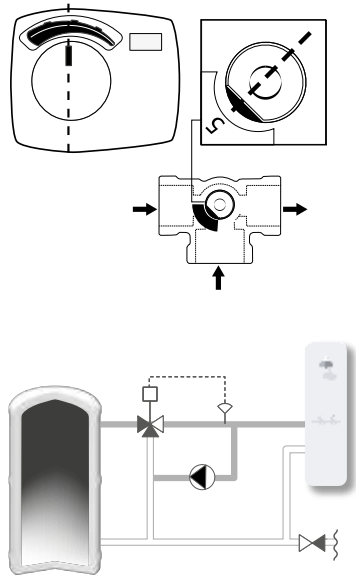

SERIES 3F, 3MG, 3G

SERIES VRH130

a

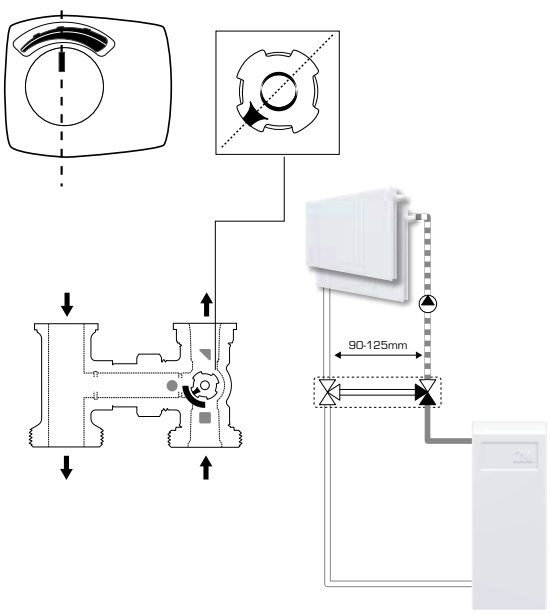

b

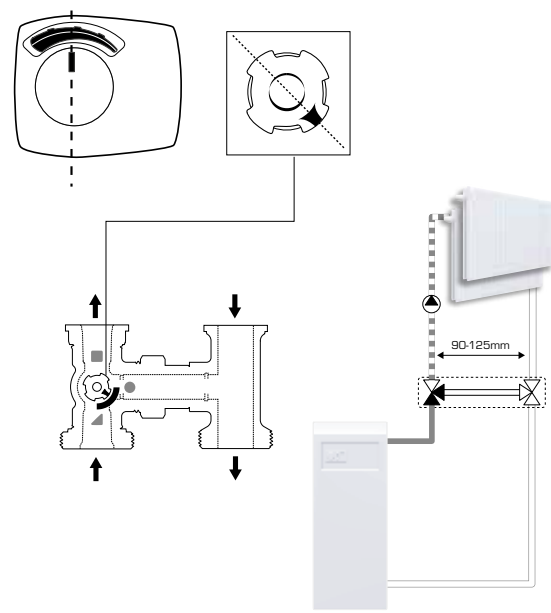

i

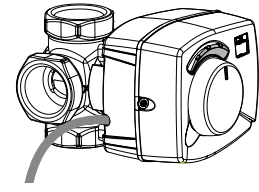
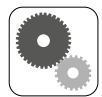
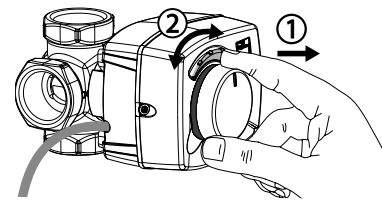

Piping Schematics are General Representations