

ferroli

CONNECT



CE

IT Manuale d'Installazione e Uso

EN Installation and Use Manual

ES Manual de instalación y uso

FR Notice d'installation et d'utilisation

RO Manual de instalare și utilizare

RU Руководство по установке и эксплуатации

PL Instrukcja instalacji i obsługi

NL Handleiding voor installatie en gebruik

1.	Introduzione	4
2.	Norme generali di sicurezza	4
3.	Classe di controllo secondo regolamento ErP	4
4.	Per l'installatore	5
4.1	Contenuto	5
4.2	Installazione del ricevitore	6
4.3	Installazione termostato	8
4.4	Montaggio supporto termostato	9
5.	Per utente finale	10
5.1	Pulsanti e Icone	10
5.2	Diagramma funzionale	12
5.3	Configurazione sistema	13
5.3.1	Creazione account	13
5.4	Configurazione RF (Ricevitore - Termostato)	13
5.5	Configurazione Wi-Fi (Ricevitore- Router)	14
5.6	APP СОИИЕСТ	15
5.6.1	Modalità manuale	18
5.6.2	Modalità "Programmazione settimanale"	19
5.6.3	Modalità vacanze	23
5.6.4	Modalità Termostato spento	23
5.7	Termostato	24
5.7.1	Operazioni base	24
5.8	Compensazione con temperatura esterna.	28
5.9	Ricevitore	29
6.	Specifiche tecniche	30

1. INTRODUZIONE

Gentile cliente, grazie per avere scelto il termostato smart CONNECT.

Ti permetterà di controllare con precisione la temperatura ambiente e grazie alla connettività Wi-Fi è controllabile da remoto tramite la APP dedicata.

Questo manuale è inteso per installatori e utenti finale.

L'elemento principale del sistema è il cronotermostato che può gestire i programmi orari impostati dall'APP, misurare la temperatura di zona e inviare i comandi di accensione/spagnimento alla centralina remota, collegata direttamente alla caldaia.

2. NORME GENERALI DI SICUREZZA

- Leggere attentamente le istruzioni contenute in questo manuale
- Dopo l'installazione, informare l'utente sulle funzionalità del dispositivo e lasciargli questo libretto che dovrà essere conservato con cura in quanto parte integrante del prodotto, che potrà poi essere usato in futuro come riferimento
- L'installazione e la manutenzione dovranno essere effettuati da personale esperto e qualificato, secondo le regole vigenti e in accordo alle istruzioni del costruttore. Non eseguire alcune operazioni sulle parti di controllo sigillate.
- Rimuovere l'alimentazione elettrica prima della pulizia.
- Non posizionare il dispositivo vicino a fonti di calore.
- Tenere lontano dalla portata dei bambini

3. CLASSE DI CONTROLLO SECONDO REGOLAMENTO ERP

Con riferimento al regolamento delegato (UE) N. 811/2013, i dati rappresentati nella tabella possono essere usati a completamento dell'etichettatura di apparecchi per riscaldamento.

Possibili combinazioni con CONNECT, relative classi di configurazione e contributo energetico al sistema.

Tipo caldaia	CONNECT	Classe e contributo
Caldaia con temperatura mandata fissa (On-Off)	Tipo On-Off	I = 1%
Caldaia con temperatura mandata variabile (set point con bus di comunicazione)	Collegamento tramite bus di comunicazione. Set point mandata calcolato in base alla temperatura ambiente ed esterna.	VI = 4%
	Collegamento tramite bus di comunicazione. Set point mandata calcolato in base almeno a 3 distinte temperature ambiente (richiesti almeno 3 termostati e 3 valvole di zone)	VIII = 5%

4. PER L'INSTALLATORE

4.1 Contenuto

La scatola include le seguenti parti:



Trasmettitore
cronotermostato



Ricevitore



Manuale



Cavo USB



Alimentatore

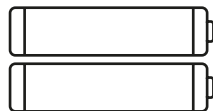

Batterie tipo AAA



Supporto da tavolo

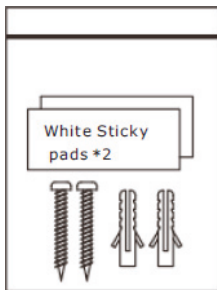

Accessori

4.2 Installazione del ricevitore

ATTENZIONE: rimuovere l'alimentazione dalla caldaia prima di eseguire il collegamento, per proteggere il dispositivo. L'operazione deve essere effettuata da personale esperto. Il ricevitore può lavorare con il protocollo OpenTherm o con il contatto On-Off.

Usare la placchetta magnetica o il biadesivo, forniti tra gli accessori, per posizionare il ricevitore nella posizione più opportuna in funzione della qualità della superficie, oppure

usare le viti per fissarlo direttamente al muro.

L'installazione del gateway deve essere effettuata all'interno dello stabile e questo non deve essere schermato da eventuali involucri metallici.

Opzione OpenTherm (A fig. 1): Collegare i due fili rossi con etichetta **OTBus**, provenienti dal ricevitore, alla caldaia dove è previsto il collegamento **OpenTherm**. Lasciare scollegati gli altri due fili. In questo caso si hanno a disposizione maggiori informazioni sullo stato della caldaia (vedi "5.7.1 Operazioni base" a pag. 24).

Opzione On-Off (B fig. 1): Collegare i due fili neri con etichetta **ON/OFF**, provenienti dal ricevitore, alla caldaia dove è previsto il collegamento al termostato **ON/OFF**. Lasciare scollegati gli altri due fili.

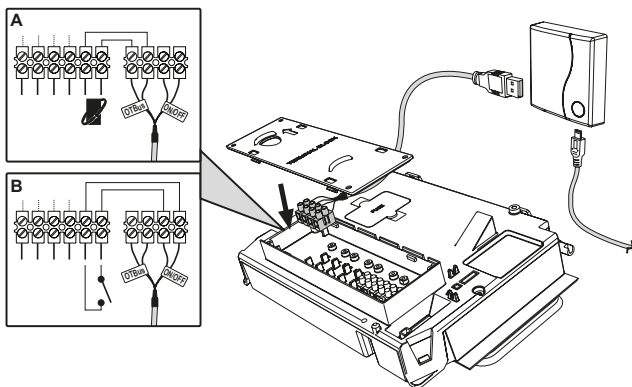

fig. 1

Una volta alimentato, i led lampeggiano per un istante.

4.3 Installazione termostato

Separare COINNECT dalla base fig. 2.

Fissare la base utilizzando le viti a corredo fig. 3.

Nel caso di termostato direttamente collegato alla caldaia oppure ad una valvola di zona, è necessario collegare i cavi nell'apposito morsetto fig. 4.

Inserire 2 batterie da 1,5V tipo AAA fig. 5.

Agganciare COINNECT sulla base fig. 6.

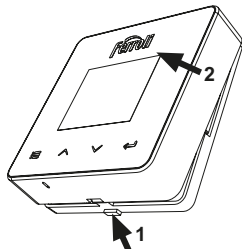

fig. 2

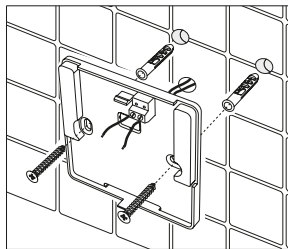

fig. 3

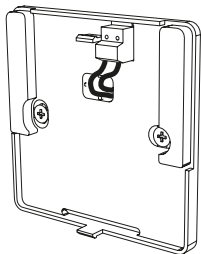

fig. 4

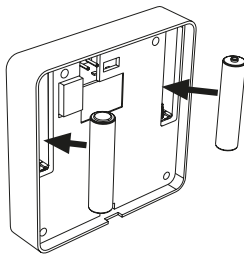

fig. 5

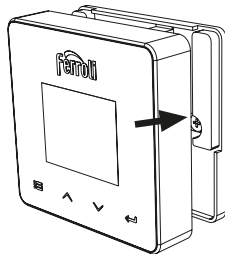

fig. 6

4.4 Montaggio supporto termostato

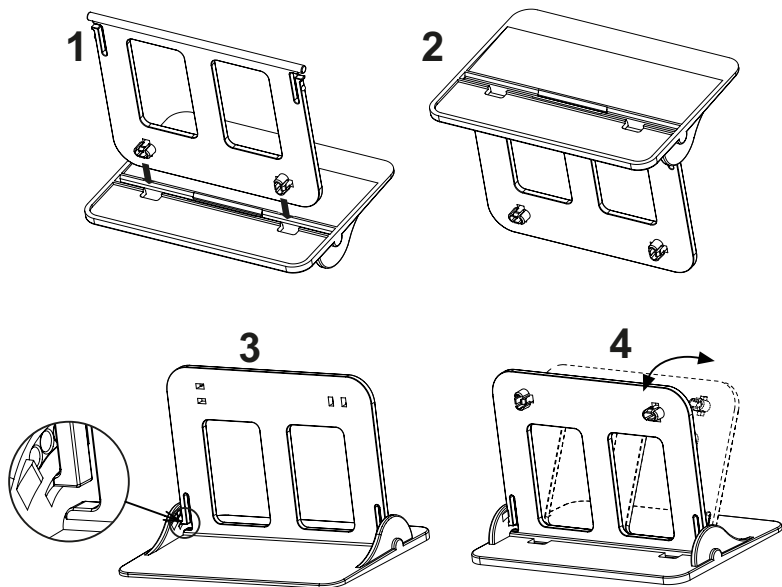

fig. 7 - Supporto termostato

5. PER UTENTE FINALE

5.1 Pulsanti e Icone

Qui di seguito c'è una descrizione dei simboli sul display e il significato dei pulsanti.

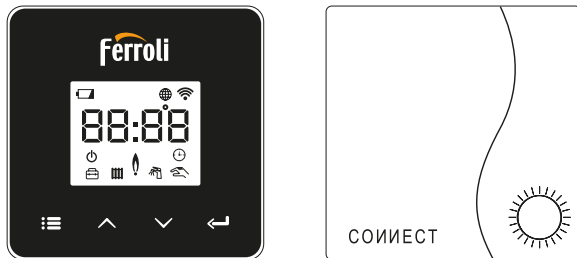

fig. 8

Icona	Descrizione
	Riscaldamento
	Sanitario
	Richiesta calore
	OFF
	Modalità AUTO
	Modalità MANUALE
	Modalità VACANZE

Icona	Descrizione
	Connessione RF
	Connessione WiFi
	Livello batteria basso
	Temperatura e orario
	modalità/salva/esci
	incrementa
	decrementa
	set
	Tasto LED

Batteria: Quando il livello della batteria è insufficiente, si attiva l'icona sullo schermo.

Fiamma

- » Termostato collegato a una caldaia on-off, l'icona indica lo stato della richiesta.
- » Termostato collegato a una caldaia OpenTherm, l'icona indica lo stato del bruciatore.

Note: alla prima accensione il termostato si configura in automatico nella modalità collegamento a filo **On-Off**.

Quando il termostato e il ricevitore Wifi sono collegati alla rete wireless, il termostato commuta automaticamente in modalità **RF On-Off**.

Quando il ricevitore Wifi è collegato a una caldaia OpenTherm, il termostato commuta automaticamente nella modalità **RF OpenTherm**.

Se il termostato si è configurato come RF (on-off oppure OpenTherm) non commuta automaticamente in modalità **filo On-Off**. Questo può essere fatto solo togliendo e rimettendo le pile.

Sanitario: l'icona sta ad indicare che il sanitario è attivo.

Note: l'icona è presente solo nel caso di collegamento RF con caldaie OpenTherm.

Riscaldamento: l'icona sta ad indicare che il riscaldamento è attivo.

Note: l'icona è presente solo nel caso di collegamento RF con caldaie OpenTherm.

Temperatura: viene visualizzata la temperatura ambiente o gli errori:

E82: errore di comunicazione RF

E83: errore di comunicazione OpenTherm

5.2 Diagramma funzionale

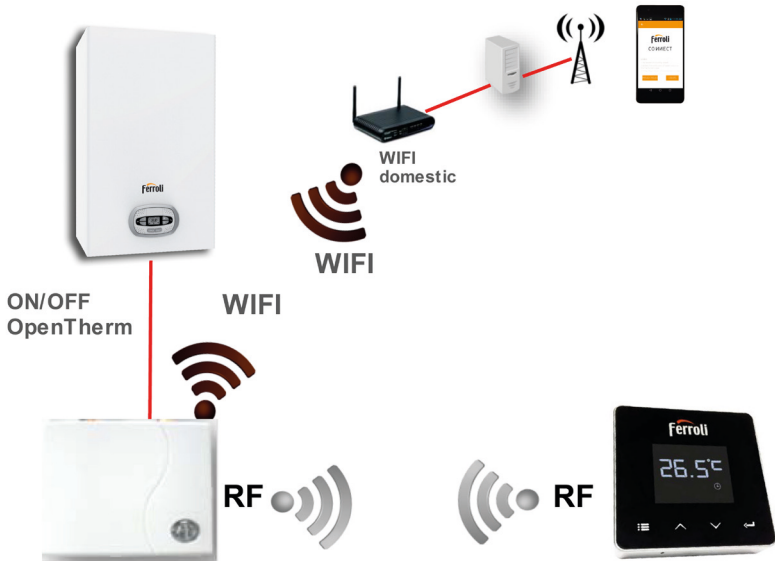

fig. 9

5.3 Configurazione sistema

Per permettere il corretto funzionamento col proprio dispositivo (Tablet o smartphone) è necessario seguire i seguenti passi:

- Scaricare l'App (CONNECT) direttamente dall'App Store del vostro dispositivo oppure utilizzando il QR CODE posto all'esterno della confezione.
- Dopo l'installazione procedere alla creazione dell'account.





5.3.1 Creazione account

- Assicurarsi che il proprio dispositivo SMARTPHONE/TABLET sia collegato alla rete Wifi.
- Aprire l'APP dedicata, e cliccare su "Registra".
- Inserire i dati richiesti e premere su verifica codice.
- Per confermare la registrazione, inserire il codice ricevuto tramite l'e-mail inserita precedentemente.

Per gestire la caldaia da più utenze, entrare con lo stesso account.

5.4 Configurazione RF (Ricevitore - Termostato)

Per stabilire la connessione RF tra termostato e ricevitore, eseguire i seguenti passi:

- Premere il tasto led del ricevitore finché lampeggia (circa 7 secondi).
- Nel termostato tenere premuto il tasto "set"  per qualche secondo fino al lampeggio del display.
- Premere il tasto  fino a visualizzare  e premere il tasto "set" .
- Alla comparsa del messaggio "r01, r02...r08" la connessione è avvenuta. Premere nuovamente il tasto "set" .

Nota: lo scambio di dati tra termostato e ricevitore avviene entro 2 minuti

5.5 Configurazione Wi-Fi (Ricevitore- Router)

Connettersi col proprio dispositivo Smartphone / Tablet alla rete Wifi locale.

- Cliccare “+” ed inserire la password della rete locale
- Premere “avanti” ⊖.
- Nel ricevitore premere per un istante il pulsante WPS con apposito utensile
- Premere “avanti” ⊖.
- Seguire le istruzioni dell'APP

Se la procedura non è andata a buon fine:

- Controllare la connessione Wifi del dispositivo mobile (la configurazione deve essere fatta con il Wifi)
- Controllare il router, riavviare il dispositivo mobile e ripetere le operazioni

5.6 APP CONNECT

Nella schermata principale (fig. 10), premere, dove indicato, per accedere al controllo di una delle caldaie configurate.

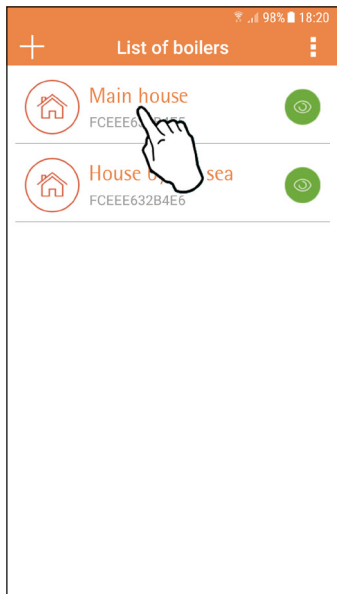

fig. 10 - Schermata principale

Nella schermata successiva (fig. 11) premere **A** per gestire la termoregolazione ambiente oppure premere **B** per visualizzare lo stato della caldaia.

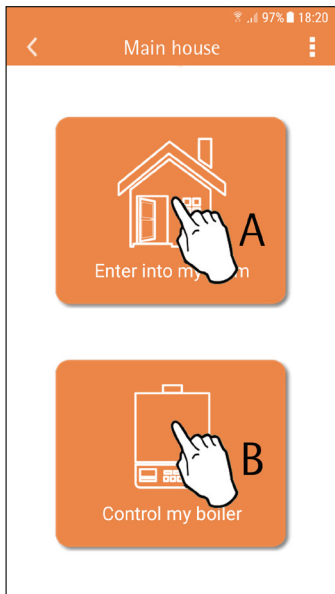

fig. 11 -



In questa schermata è possibile entrare nel settaggio del cronocomando remoto collegato.

Se sono presenti più zone, selezionare quella di interesse.

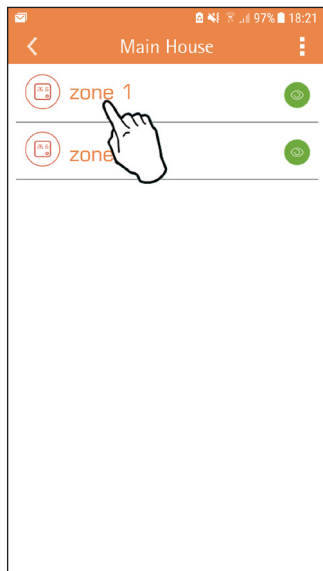

fig. 12 - Controllo Cronocomando

Le modalità possibili sono:





-  Modalità manuale
-  Programmazione settimanale
-  Modalità vacanze
-  Termostato spento



fig. 13 - Possibili modalità



In questa schermata (fig. 14), se la caldaia è collegata tramite protocollo OpenTherm, è possibile visualizzarne lo stato. È inoltre possibile, cliccando sui simboli , cambiare i set point del sanitario e del riscaldamento in caldaia. Se la caldaia è collegata tramite contatto On-Off, viene visualizzato solo lo stato della richiesta (fig. 15).

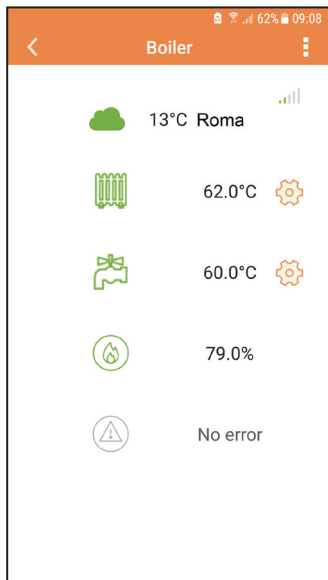

fig. 14 - Con OpenTherm

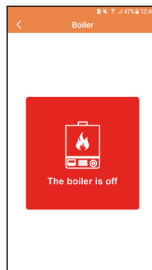
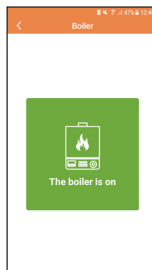

fig. 15 Con Termostato ambiente



5.6.1 Modalità manuale

In questa modalità è possibile impostare la temperatura ambiente desiderata.

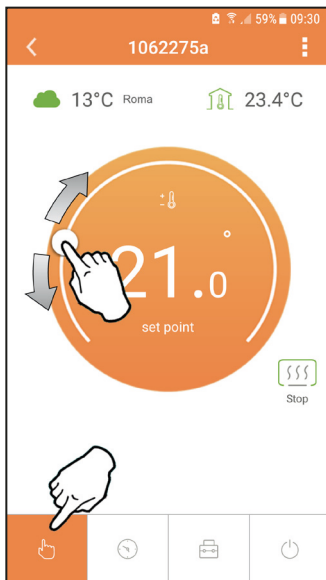

fig. 16

5.6.2 Modalità “Programmazione settimanale

In questa modalità è possibile impostare la temperatura desiderata nelle varie fasce orarie di tutti i giorni della settimana premendo nel punto “B” indicato in fig. 17.

È inoltre possibile cambiare temporaneamente la temperatura desiderata (fino alla successiva fascia oraria) agendo sul punto “A”, senza modificare il programma.

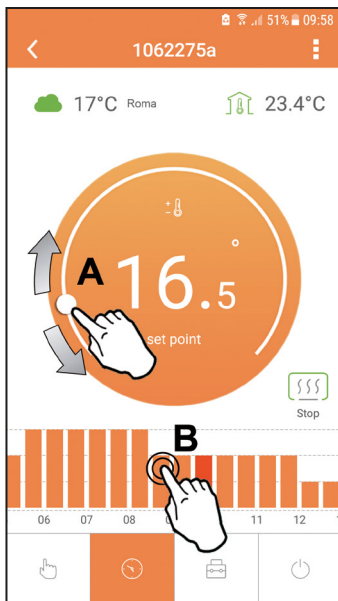

fig. 17

Si hanno a disposizione 3 livelli di temperatura: **T3** (Livello COMFORT 1), **T2** (Livello COMFORT 2) e **T1** (Livello ECO).

Per impostare la temperatura dei livelli **T1**, **T2** e **T3**, seguire la sequenza sottoriportata.

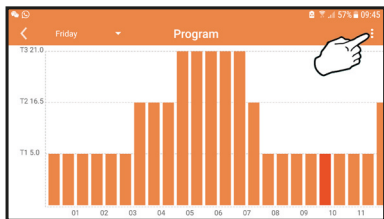

fig. 18

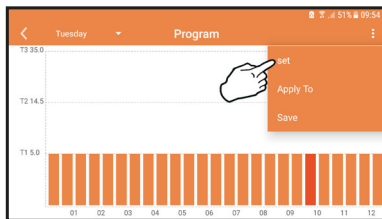

fig. 19

Settare le temperature e confermare.

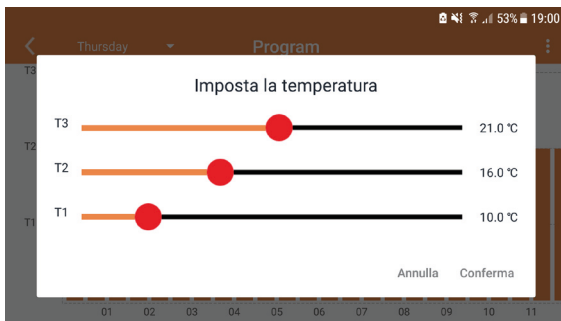

fig. 20 Settaggio temperature

Per cambiare le fasce orarie, premere nell'area che si vuole modificare.

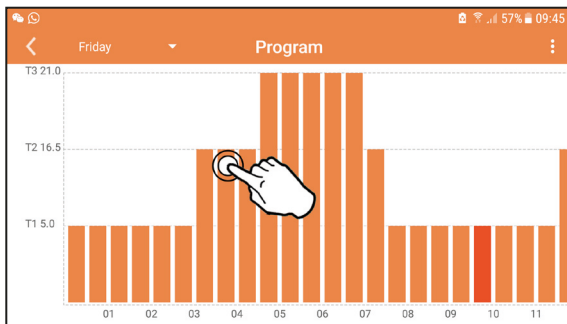

fig. 21

Dopo aver programmato le temperature, salvare la configurazione.

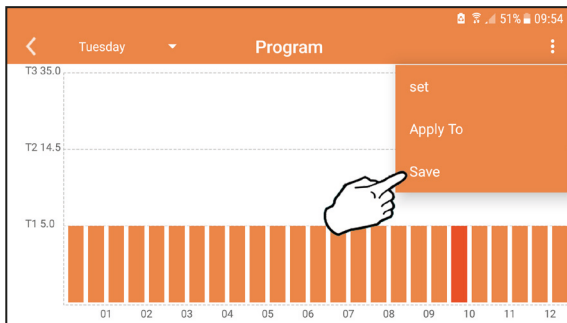

fig. 22

Cliccare “applica” per scegliere i giorni nei quali copiare le impostazione appena effettuate.

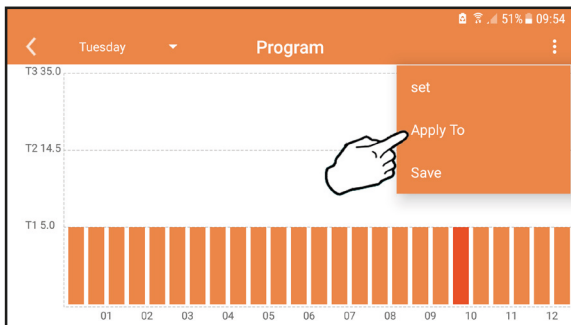



fig. 23

Se è disponibile l'informazione della temperatura esterna (via WEB o OpenTherm) la temperatura impostata in caldaia tiene conto di questo valore per regolare la mandata. Se la temperatura esterna non è disponibile, la mandata viene regolata in base alla temperatura ambiente impostata.

5.6.3 Modalità vacanze

In questa modalità la caldaia viene spenta e verrà riattivata nel caso in cui la temperatura scenda sotto il set point indicato.

Premendo sull'icona impostazione , si potrà impostare la data di fine vacanza.

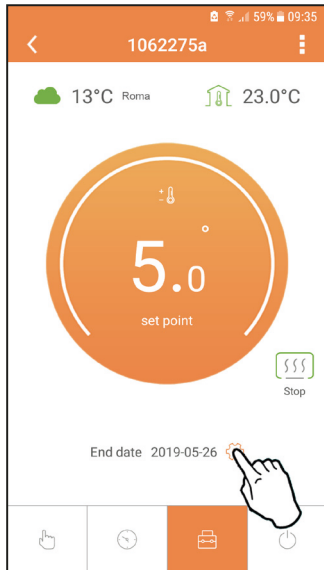

fig. 24

5.6.4 Modalità Termostato spento

In questa modalità la caldaia viene spenta e verrà riattivata nel caso in cui la temperatura scenda sotto i 5°C.

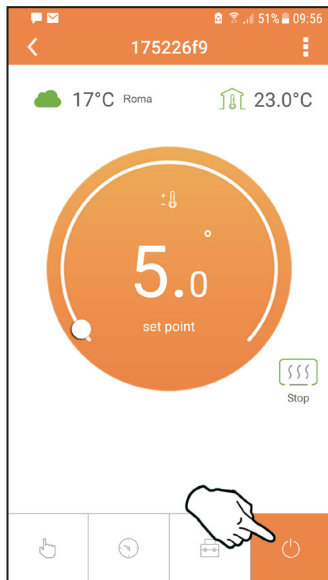

















fig. 25

5.7 Termostato







5.7.1 Operazioni base

1. Premendo il tasto “**mode**”  si commuta tra le varie modalità:
 - a. **Off** : in questa modalità la richiesta di calore è disabilitata, resta attiva solo la modalità antigelo.
 - b. **Vacanza** : la temperatura impostata è quella di antigelo per un numero di giorni impostati attraverso i tasti  .
 - c. **Automatico** : la temperatura richiesta è quella del programma settimanale impostata tramite APP. Se il programma non è stato impostato, viene usato quello di default del sistema.
 - d. **Manuale** : la temperatura viene impostata manualmente direttamente sul termostato.
2. **Set temperatura:**
 - a. **Manuale:** agire sui tasti  .
3. **Menu impostazioni:** premendo il tasto “**set**”  per circa 2 secondi si entra nel menu impostazioni.
 - a. “ e ” si scorre il menu
 - b. “**set**”  si entra nel parametro selezionato
 - c. “**mode**”  si ritorna al menu principale
4. In caso di un’anomalia della caldaia, viene riportato il codice dell’errore anche sul display del termostato. È possibile sbloccare l’anomalia tramite il tasto “**set**” .









Per la descrizione dell’anomalia, fare riferimento al libretto della caldaia.

No.	Parametro	Display	descrizione
1)	Orologio	14:05	Imposta ore, minuti, anno (y), mese (m), giorno (d).
2)	Temperatura	23.0°C	Imposta la temperatura di CFT1, CFT2, ECO, FRST
3)	Codice COUP	COUP	Codice RF (vedi paragrafo 5.4 a pagina 13)
4)	Set point sanitario	48.0	Imposta la temperatura del sanitario, funzione disponibile solo con collegamento OpenTherm
5)	Informazioni caldaia	INFO	Lettura di alcuni parametri della caldaia solo con collegamento OpenTherm
6)	Dati installatore	PL	Parametri per installatore
7)	Esci	EXIT	Ritorna alla pagina iniziale

1) Orologio

- » Premere i pulsanti  e  per selezionare il menu orologio, e poi “set”  per entrare.
- » Premendo il tasto “set”  si seleziona il dato da cambiare con questa successione: 13:00 ora, 13:42 minuti, 19 y anno, 02 m mese, 21 d giorno.
- » Premere i pulsanti  e  per cambiare il valore.
- » Premere “mode”  per tornare.







2) Temperatura

- » Premere i pulsanti  e  per selezionare il menu temperatura, e poi “set”  per entrare.
- » Premere i pulsanti  e  per selezionare le temperature da modificare:
- » **comfort** (CF) – **economic** (EC) – **antigelo** (FR)
- » Premere i pulsanti  e  per modificare il valore della temperatura scelta.
- » Premere “set”  o “mode”  per tornare al menu precedente.





3) Codice di accoppiamento

- » Vedi paragrafo 5.4 a pagina 13.

4) Temperature sanitario (solo caldaie OpenTherm)

- » Premere I pulsanti   per selezionare la temperatura sanitario, e poi “set”  per entrare.
- » Premere I pulsanti   per cambiare il valore.
- » Premere “set”  o “mode”  per tornare al menu precedente.
Nota: se il termostato riceve il dato dalla caldaia, allora visualizza questo valore, altrimenti il range di impostazione è 30 – 60°C.















5) Informazioni dalla caldaia (solo caldaie OpenTherm)

- » Premere I pulsanti   per selezionare informazioni, e poi “set” per entrare.
- » Quando viene visualizzato “- - -” significa che il data non è disponibile nel boiler
- » Premere “set”  o “mode”  per tornare al menu precedente.

No.	informazione
1	Set point mandata
2	Sonda mandata
3	Sonda ritorno
4	Temperatura sanitario
5	Temperatura esterna
6	Percentuale potenza
7	Prelievo sanitario
8	Pressione impianto

6) Impostazioni avanzate (PL)

Parametri per installatore

- » Premere i pulsanti   per selezionare il menu “PL” e poi “set”  per entrare.
- » Scorrere, utilizzando i tasti  , fino a raggiungere il valore “PS 10” e quindi premere “set” . Selezionare il parametro da modificare (vedi tabella sottostante) utilizzando i tasti   e premere “set” . Modificare il parametro scelto utilizzando i tasti   e quindi premere “set”  per confermare la modifica.
- » Premere “set”  o “mode”  per tornare al menu precedente.

Param	Descrizione	Step	Unit	Default	Range
CAU	Calibrazione sensore ambiente	0.1	°C	Temperatura ambiente	-7.0 + 7.0 °C
FAC	Reset fabbrica		---	NO	NO - YES
HO _n	Hysteresis ON (*)	0.1	°C	0.4	0.0 ÷ 2.0
HO _F	Hysteresis OFF (**)	0.1	°C	0.1	0.0 ÷ 2.0
BL	Durata illuminazione display			08	03 ÷ 15
HHCH	Max set point mandata (***)	1	°C	85	45 ÷ 85°C
LLCH	Min set point mandata (***)	1	°C	30	10 - HHCH
CL	Curva climatica (***)		---	1.2	0.0, 0.2, 0.4, 0.6, 0.8, 1.0, 1.2, 1.5, 2.0, 2.5, 3.0
HHBO	CH set point caldaia (***)	1	°C	85°C	30 ÷ 85°C
EXIT	Exit				

(*) la richiesta si attiva se $T. amb < Tset -HO_n$

(**) la richiesta si spegne se $T. amb > Tset + HO_F$

(***) solo con connessione OpenTherm

7) Exit

» Premere “set” ← per tornare al menù principale.

5.8 Compensazione con temperatura esterna.

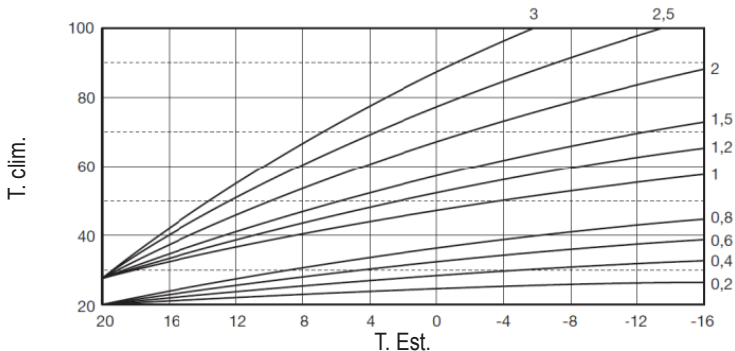

Grazie alla temperatura esterna (dal WEB o collegata alla caldaia) il termostato calcola la temperatura di mandata caldaia ottimizzando i consumi. Agendo sul parametro CLI (vedi menu installatore PL), si regola il contributo secondo la formula:

$$T_{mandata} = T_{clim} + 10 \times CLI \times (T_3 - T_4)$$

Per disabilitare la sonda esterna, impostare CLI = 0, in tal caso si ha:

$$T_{mandata} = LLCH + 10 \times (T_3 - T_4)$$

T₃ = set ambiente





















T₄ = temp ambiente

T_{clim} = v.di grafico

LLCH = vedi menu installatore PL

5.9 Ricevitore

L'unità ricevente permette lo scambio di dati tra Termostato e caldaia.
 È presente un pulsante con led colorati ad indicare lo stato del sistema.

LED Verde	LED Rosso	DESCRIZIONE				
Lampeggiante (lento)	Lampeggiante (lento)					
ON	Lampeggiante (lento)					
ON	OFF					
Lampeggiante (veloce)	OFF				Connessione WiFi in corso	
OFF	Lampeggiante (veloce)				Connessione RF in corso	

6. SPECIFICHE TECNICHE

Elettriche/ meccaniche	Alimentazione	100 ~ 240Vac, 50 / 60 Hz
	Consumi	1,2W
	Uscita relè	Contatto pulito - 0,25A – 230Vac, 2A - 30Vdc
	Termostato	90 x 90 x 22 mm
	Ricevitore	86 x 86 x 21 mm
	Colore	Nero + argento
	Materiale involucro	ABS + alluminio
	Sensore temperature	incorporato
Wi-Fi	Standard Wi-Fi	802.11 b/g/n
	Frequenza Wi-Fi	2.412 GHz – 2.484 GHz
	Frequenza RF	868 MHz [FSK]
	Distanza RF	max 40m in campo libero (*)
	Antenna	incorporata
	Sicurezza	WEP / WPA - PSK / WPA2 - PSK
	Protocollo	IPv4, TCP
	Tipo rete	STA

() Eventuali ostacoli o muri possono ridurre la portata del segnale WiFi, In tal caso avvicinare il gateway al router, o utilizzare un extender WiFi.*

1.	Introduction	32
2.	General safety rules.....	32
3.	Control class according to ErP regulations	32
4.	For the installer	33
4.1	Contents	33
4.2	Installing the receiver.....	34
4.3	Thermostat installation.....	36
4.4	Thermostat support assembly	37
5.	For the end user	38
5.1	Buttons and Icons	38
5.2	Functional diagram	40
5.3	System configuration	41
5.3.1	Creating the account	41
5.4	RF configuration (Receiver - Thermostat)	41
5.5	Wi-Fi configuration (Receiver-Router)	42
5.6	APP CONNECT	43
5.6.1	Manual mode	46
5.6.2	Weekly programming mode	47
5.6.3	Vacation mode	51
5.6.4	Thermostat mode off	51
5.7	Thermostat.....	52
5.7.1	Basic operations.....	52
5.8	Compensation with outside temperature.....	56
5.9	Receiver.....	57
6.	Technical specifications.....	58

1. INTRODUCTION

Dear customer, thank you for choosing the CONNNECT smart thermostat. It will allow you to accurately control the room temperature and, thanks to Wi-Fi connectivity, can be controlled remotely via the dedicated APP.

This manual is intended for installers and end users.

The main component of the system is the programmable thermostat that can manage the time programs set by the APP, measure the zone temperature and send on/off commands to the remote control unit, connected directly to the boiler.

2. GENERAL SAFETY RULES

- Read the instructions in this manual carefully
- After installation, inform the user about the device's functions, and giving the user this booklet to be kept carefully as an integral part of the product and subsequently used for future reference
- Installation and maintenance must be carried out by qualified personnel, according to the rules in force and the manufacturer's instructions. Do not perform any operation on the sealed control parts.
- Remove the electrical power supply before cleaning.
- Do not place the device near heat sources.
- Keep out of the reach of children

3. CONTROL CLASS ACCORDING TO ERP REGULATIONS

With reference to the applicable regulation (EU) No. 811/2013, the data shown in the table can be used to complete the labeling of heating units.

Possible combinations with CONNNECT, related configuration classes and energy contribution to the system.

Boiler type	CONNECT	Class and contribution
Boiler with fixed flow temperature (On-Off)	On-Off type	I = 1%
Boiler with variable flow temperature (set point with communication bus)	Connection via communication bus. Flow set point calculated according to the room and outdoor temperature.	VI = 4%
	Connection via communication bus. Flow set point calculated according to at least 3 different ambient temperatures (at least 3 thermostats and 3 zone valves required)	VIII = 5%

4. FOR THE INSTALLER

4.1 Contents

The box includes the following parts:



Transmitter
programmable thermostat



Receiver



Manual



USB cable



Power supply

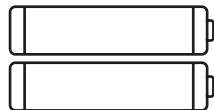

AAA type batteries



Table support

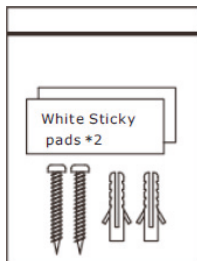

Accessories

4.2 Installing the receiver

ATTENTION: To protect the device, remove the power supply from the boiler before making the connection. The operation must be carried out by qualified personnel. The receiver can work with the OpenTherm protocol or with the On-Off contact. Use the magnetic plate or the double-sided adhesive (supplied with the accessories) to place the receiver in the best position according to the quality of the surface, or use the screws to secure it directly to the wall.

The gateway must be installed inside the building and should not be shielded by any metal enclosures.

OpenTherm option (A fig. 1): Connect the two red wires with label **OTBus**, coming from the receiver, to the boiler where the **OpenTherm** connection is foreseen. Leave the other two wires disconnected. In this case, more information is available on boiler status (see “5.7.1 Basic operations” on page 52).

On-Off option (B fig. 1): Connect the two black wires with label **ON/OFF**, coming from the receiver, to the boiler where the connection to the **ON/OFF** thermostat is foreseen. Leave the other two wires disconnected.

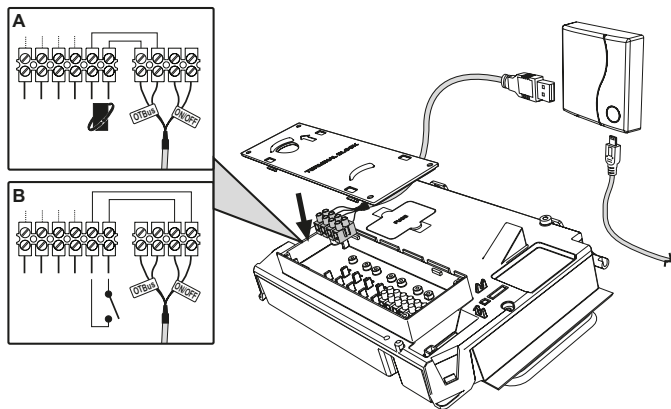

fig. 1

Once powered, the LEDs flash briefly.

4.3 Thermostat installation

Separate CONNECT from the base fig. 2.

Secure the base using the screws provided fig. 3.

In case of thermostat directly connected to the boiler or to a zone valve, the cables must be connected in the appropriate terminal fig. 4.

Insert two 1.5V AAA batteries fig. 5.

Hook CONNECT on the base fig. 6.

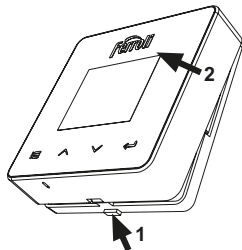

fig. 2

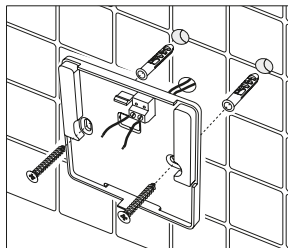

fig. 3

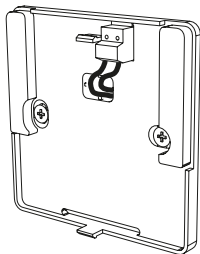

fig. 4

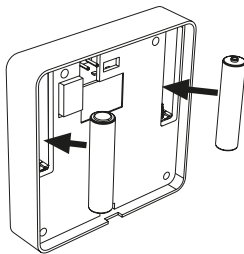

fig. 5

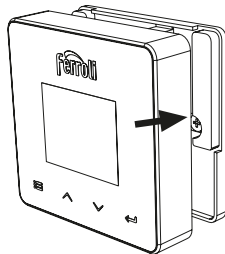

fig. 6

4.4 Thermostat support assembly

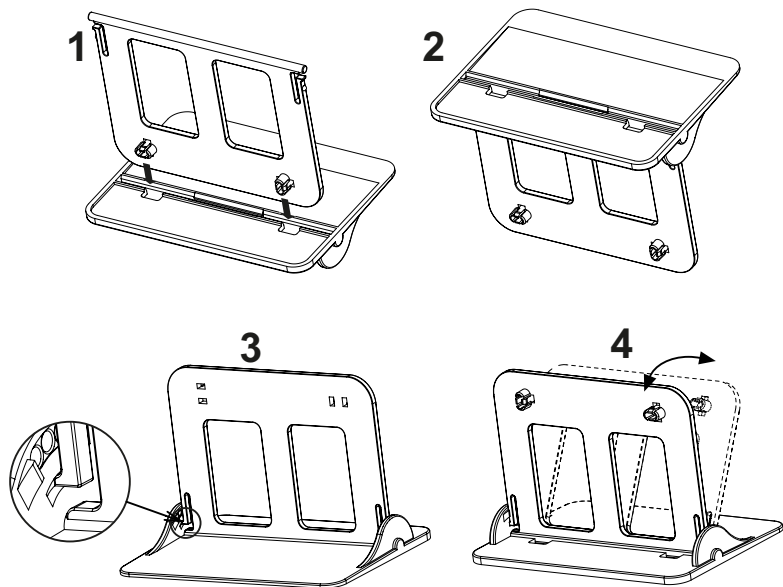

fig. 7 - Thermostat support

5. FOR THE END USER

5.1 Buttons and Icons

A description of the symbols on the display and the meaning of the buttons is given below.

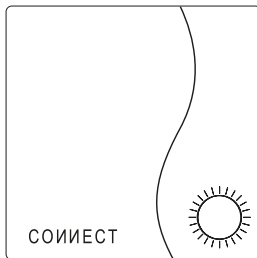

fig. 8

Icon	Description
	Heating
	DHW (domestic hot water)
	Heat demand
	OFF
	AUTO mode
	MANUAL mode
	VACATION mode

Icon	Description
	RF connection
	WiFi connection
	Low battery level
	Temperature and time
	mode/save/exit
	increase
	decrease
	set
	LED button

Battery: The icon on the screen is activated when the battery level is too low.

Flame

- » Thermostat connected to an on-off boiler, the icon indicates request status.
- » Thermostat connected to an OpenTherm boiler, the icon indicates burner status.

Note: *At first activation the thermostat is configured automatically in **On-Off** wire connection mode.*

*When the thermostat and the WiFi receiver are connected to the wireless network, the thermostat automatically switches to **RF On-Off** mode.*

*When the WiFi receiver is connected to an OpenTherm boiler, the thermostat automatically switches to **RF OpenTherm** mode.*

*If the thermostat has been configured as RF (on-off or OpenTherm) it does not automatically switch to **On-Off wire** mode. This can only be done by removing and putting back the batteries.*

DHW: the icon indicates that DHW is on.

Note: *The icon is only present in the case of RF connection with OpenTherm boilers.*

Heating: the icon indicates that heating is active.

Note: *The icon is only present in the case of RF connection with OpenTherm boilers.*

Temperature: the room temperature or errors are displayed:

E82: *RF communication error*

E83: *OpenTherm communication error*

5.2 Functional diagram

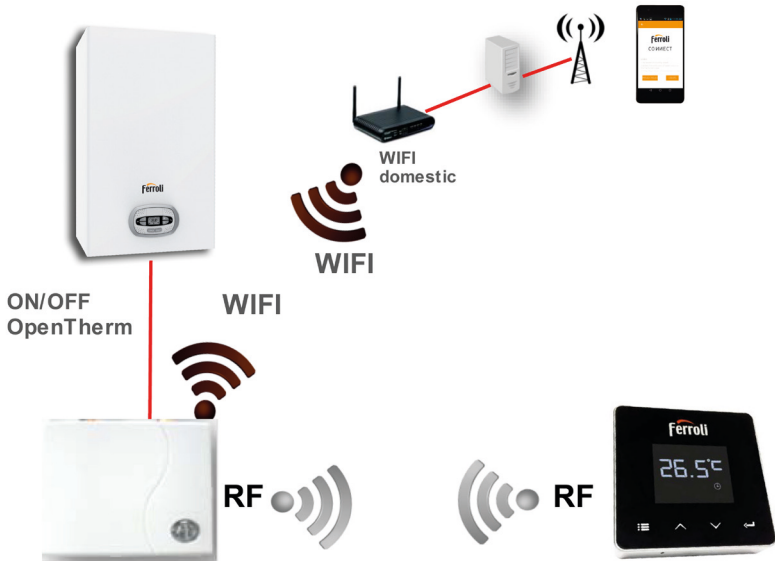

fig. 9

5.3 System configuration

To allow proper operation with your device (Tablet or smartphone), proceed as follows:

- Download the App (CONNECT) directly from the App Store of your device or using the QR CODE on the outside of the package.
- After installation, create the account.





5.3.1 Creating the account

- Make sure your SMARTPHONE/TABLET device is connected to the Wifi network.
- Open the dedicated APP, and click on “Register”.
- Enter the requested data and press code verification.
- To confirm the registration, enter the code received via the email previously entered.

To manage the boiler from several users, enter with the same account.

5.4 RF configuration (Receiver - Thermostat)

To establish the RF connection between the thermostat and the receiver, proceed as follows:

- Press the receiver LED button until it flashes (about 7 seconds).
- In the thermostat keep the “set”  button pressed for a few seconds until the display flashes.
- Press the button  until displaying  and press “set” .
- When the message “r01, r02..÷..r08” appears, the connection has been made. Press “set”  again.

Note: *Data exchange between thermostat and receiver occurs within 2 minutes*

5.5 Wi-Fi configuration (Receiver-Router)

Connect with your Smartphone / Tablet device to the local WiFi network.

- Click “+” and enter the local network password
- Press “next” ⊖.
- In the receiver, briefly press the WPS button with a dedicated tool
- Press “next” ⊖.
- Follow the APP instructions

If the procedure was unsuccessful:

- Check the WiFi connection of the mobile device (the configuration must be done with WiFi)
- Check the router, restart the mobile device and repeat the operations

5.6 APP CONNECT

On the main screen (fig. 10), press where indicated to access control of one of the configured boilers.

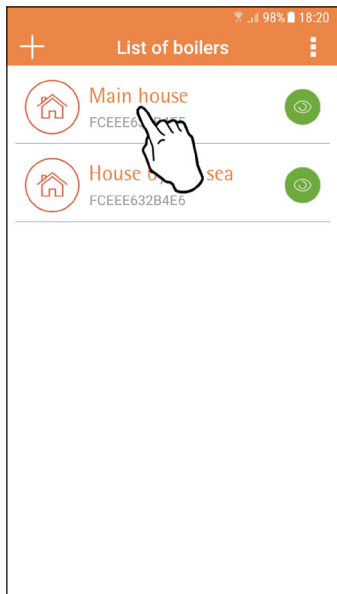

fig. 10 - Main screen

On the next screen (fig. 11) press **A** to manage room temperature control or press **B** to display boiler status.

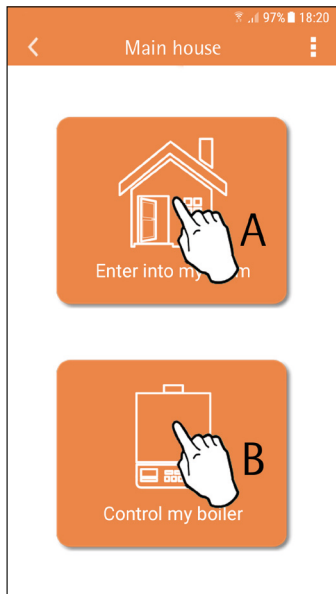

fig. 11 -



The connected remote timer control setting can be accessed on this screen.

If there are several zones, select the one required.

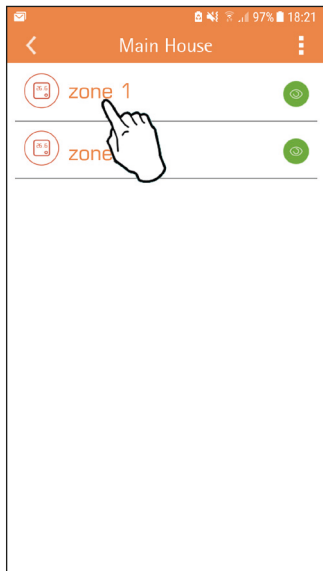

fig. 12 - Remote Timer Control

The possible modes are:





-  Manual mode
-  Weekly programming
-  Vacation mode
-  Thermostat off



fig. 13 - Possible modes



On this screen (fig. 14), if the boiler is connected via OpenTherm protocol, it is possible to display its status. Also, by clicking on the symbols , the boiler DHW and heating set points can be changed.

If the boiler is connected via On-Off contact, only the status of the request is displayed (fig. 15).

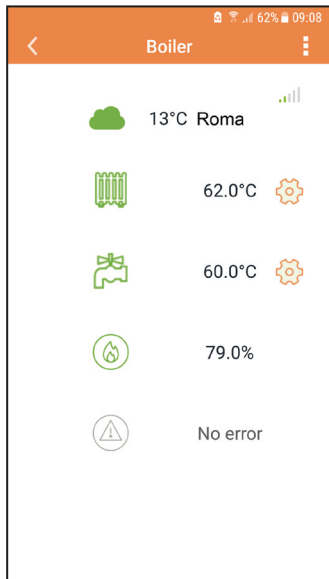

fig. 14 - With OpenTherm

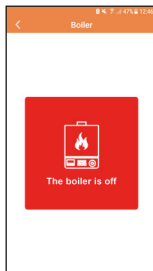
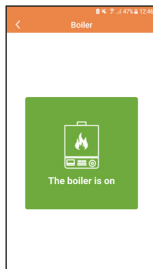

fig. 15 With room thermostat



5.6.1 Manual mode

The desired room temperature can be set in this mode.

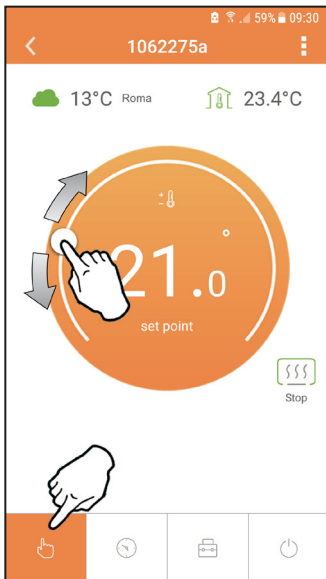

fig. 16

5.6.2 Weekly programming mode

In this mode the desired temperature for the various time slots of all days of the week can be set by pressing where (B) indicated in fig. 17.

It is also possible to temporarily change the desired temperature (until the next time slot) by acting on point “A”, without modifying the program.

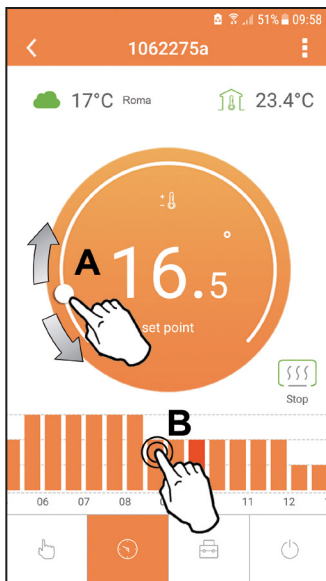

fig. 17

3 temperature levels are available: **T3** (COMFORT 1), **T2** (COMFORT 2) and **T1** (ECO).
To set the temperature of levels **T1**, **T2** and **T3**, follow the sequence given below.

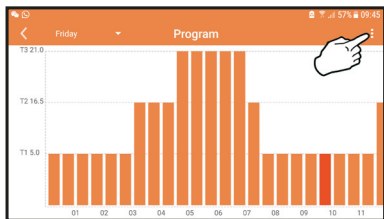

fig. 18

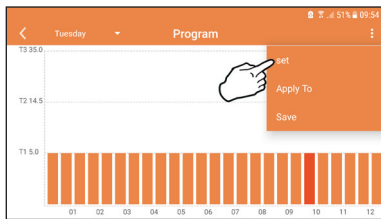

fig. 19

Set the temperatures and confirm.

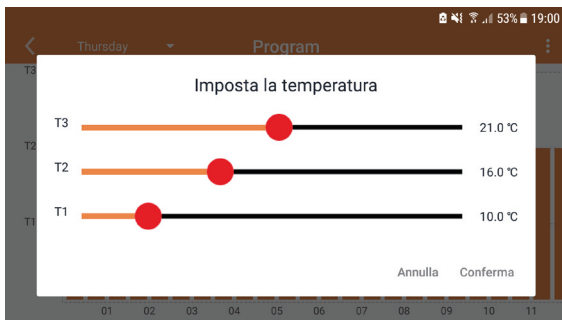

fig. 20 Setting temperatures

To change the time slots, press in the area to be changed.

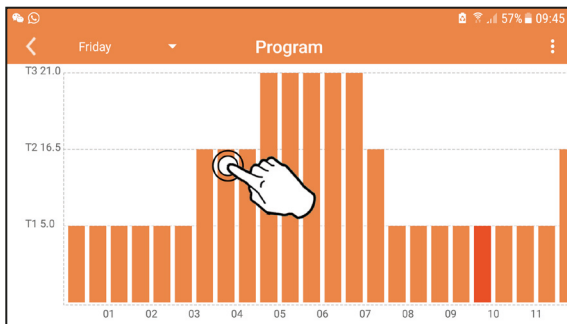

fig. 21

After programming the temperatures, save the configuration.

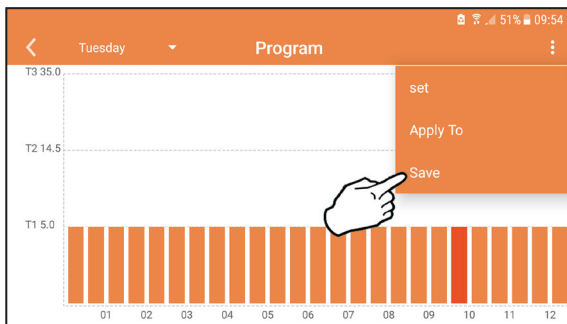

fig. 22

Click "apply" to select the days in which to copy the settings just made.

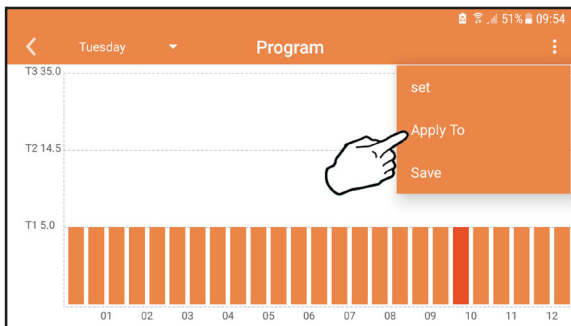



fig. 23

If the outside temperature information is available (via WEB or OpenTherm), the temperature set in the boiler takes this value into account to adjust the flow.
If the outside temperature is not available, the flow is adjusted according to the set room temperature.

5.6.3 Vacation mode

In this mode, the boiler is switched off and will be reactivated if the temperature goes below the indicated set point.

The vacation end date can be set by pressing the setting icon .

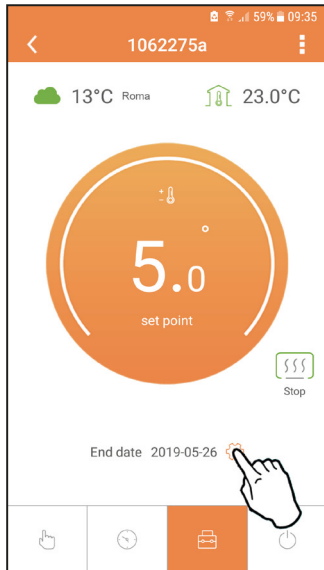

fig. 24

5.6.4 Thermostat mode off

In this mode the boiler is switched off and will be reactivated if the temperature drops below 5°C.

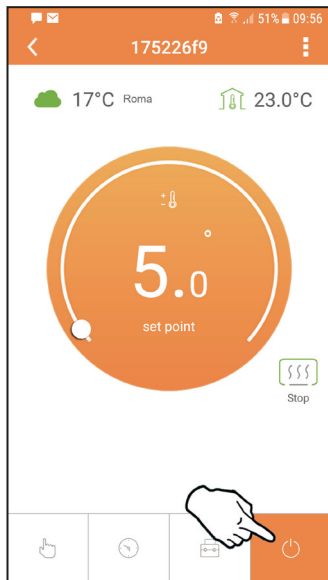















fig. 25

5.7 Thermostat







5.7.1 Basic operations

1. Press the “mode”  button to switch between the various modes:
 - a. **Off** : in this mode the heat request is disabled; only the frost protection mode remains active.
 - b. **Vacation** : the set temperature is that of frost protection energy saving for a number of days set via the buttons  .
 - c. **Automatic** : the required temperature is that of the weekly program set via APP. If the program has not been set, the system default one is used.
 - d. **Manual** : the temperature is set manually, directly on the thermostat.
2. **Temperature setting:**
 - a. **Manual:** press the buttons  .
3. **Settings menu:** press “set”  for about 2 seconds to access the settings menu.
 - a. “ and  access the selected parameter
 - c. “mode”  return to the main menu
4. In case of a boiler fault, the error code is also shown on the thermostat display. It is possible to reset the fault via the “set”  button.









For a description of the fault, refer to the boiler handbook.

No.	Parameter	Display	description
1)	Clock	14:05	Set hours, minutes, year (y), month (m), day (d).
2)	Temperature	23.0°C	Set the temperature of CFT1, CFT2, ECO, FRST
3)	COUP code	COUP	RF code (see par. 5.4 on page 41)
4)	DHW set point	DHW	Set DHW temperature, function available only with OpenTherm connection
5)	Boiler information	INFO	Reading of some boiler parameters only with OpenTherm connection
6)	Installer data	PL	Installer parameters
7)	Exit	EXIT	Return to the home page

1) Clock

- » Press the buttons  and  to select the clock menu, and then “set”  to enter.
- » Press the “set”  button to select the data to be changed with this sequence: 13:00 hour, 13:42 minutes, 19 y year, 02 m month, 21 d day.
- » Press the buttons  and  to change the value.
- » Press “mode”  to go back.







2) Temperature

- » Press the buttons  and  to select the temperature menu, and then “set”  to enter.
- » Press the buttons  and  to select the temperatures to be changed:
- » **comfort** (CFE) – **economic** (EE□) – **frost protection** (FRE)
- » Press the buttons  and  to change the value of the selected temperature.
- » Press “set”  or “mode”  to return to the previous menu.





3) Coupling code

- » See par. 5.4 on page 41.

4) DHW temperatures (OpenTherm boilers only)

- » Press the buttons   to select the DHW temperature, and then “set”  to enter.
- » Press the buttons   to change the value.
- » Press “set”  or “mode”  to return to the previous menu.
Note: If the thermostat receives the data from the boiler, then it displays this value, otherwise the setting range is 30 – 60°C.

5) Information from the boiler (OpenTherm boilers only)

- » Press the buttons   to select information, and then "set" to enter.
- » When “- - -” is displayed, it means the data is not available in the boiler
- » Press “set”  or “mode”  to return to the previous menu.

No.	information
1	Flow set point
2	Flow probe
3	Return probe
4	DHW temperature
5	Outside temperature
6	Power percentage
7	DHW draw
8	System pressure

6) Advanced settings (PL)

» *Installer parameters*

- » Press the buttons to select the “PL” menu, and then “set” to access.
- » Scroll using the buttons , until reaching the value “PS 10” then press “set” . Select the parameter to be modified (see table below) using the buttons and press “set” . Modify the selected parameter using the buttons then press “set” to confirm the change.
- » Press “set” or “mode” to return to the previous menu.

Param	Description	Step	Unit	Default	Range
CRU	Room sensor calibration	0.1	°C	Room temperature	-7.0 + 7.0 °C
FRct	Factory reset		---	NO	NO - YES
HOn	Hysteresis ON (*)	0.1	°C	0.4	0.0 ÷ 2.0
HOF	Hysteresis OFF (**)	0.1	°C	0.1	0.0 ÷ 2.0
btLt	Display illumination duration			08	03 ÷ 15
HHCH	Flow max set point (***)	1	°C	85	45 ÷ 85°C
LLCH	Flow min set point (***)	1	°C	30	10 - HHCH
CL	Climate curve (***)		---	1.2	0.0, 0.2, 0.4, 0.6, 0.8, 1.0, 1.2, 1.5, 2.0, 2.5, 3.0
HHbO	Boiler CH set point (***)	1	°C	85°C	30 ÷ 85°C
EXIT	Exit				

(*) the request is activated if $T_{amb} < T_{set} - HOn$

(**) the request is deactivated if $T_{amb} > T_{set} + HOF$

(***) only with OpenTherm connection

7) Exit

» Press “set”  to return to the main menu.

5.8 Compensation with outside temperature.

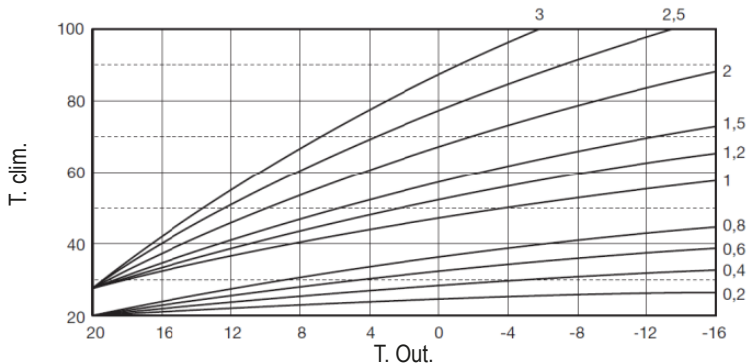

Thanks to the outside temperature (via the WEB or connected to the boiler) the thermostat calculates the boiler flow temperature, optimizing consumption. By acting on the parameter CLI (see installer menu PL), the contribution is adjusted according to the formula:

$$T_{\text{flow}} = T_{\text{clim}} + 10 \times \text{CLI} \times (T_3 - T_4)$$

To disable the external probe, set CLI = 0, which gives:

$$T_{\text{flow}} = \text{LLCH} + 10 \times (T_3 - T_4)$$

T₃ = room set point





















T₄ = room temp

T_{clim} = see chart

LLCH = see installer menu PL

5.9 Receiver

The receiver unit allows data exchange between the thermostat and the boiler.
A button with coloured LEDs indicates system status.

Green LED	Red LED	DESCRIPTION				
Slow blinking	Slow blinking					
ON	Slow blinking					
ON	OFF					
Fast blinking	OFF				WiFi connection in progress	
OFF	Fast blinking				RF connection in progress	

6. TECHNICAL SPECIFICATIONS

Electrical/ mechanical	Power supply	100 ~ 240Vac, 50 / 60 Hz
	Consumption	1.2W
	Relay output	Voltage-free - 0.25A – 230Vac, 2A - 30Vdc
	Thermostat	90 x 90 x 22
	Receiver	86 x 86 x 21
	Colour	Black + silver
	Casing material	ABS + aluminium
Wi-Fi	Temperature sensor	built-in
	Wi-Fi standard	802.11 b/g/n
	Wi-Fi frequency	2.412 GHz – 2.484 GHz
	RF frequency	868 MHz [FSK]
	RF distance	max 40m in free field (*)
	Antenna	built-in
	Safety	WEP / WPA - PSK / WPA2 - PSK
Protocol	IPv4, TCP	
Network type	STA	

() Any obstacles or walls can reduce the WiFi signal range. In this case, bring the gateway closer to the router, or use a WiFi extender.*

1.	Introducción	60
2.	Normas generales de seguridad	60
3.	Categoría de control según el reglamento ErP	60
4.	Para el instalador	61
4.1	Contenido	61
4.2	Instalación del receptor	62
4.3	Instalación del termostato	64
4.4	Montaje del soporte del termostato	65
5.	Para el usuario	66
5.1	Botones e iconos	66
5.2	Diagrama de funcionamiento	68
5.3	Configuración del sistema	69
5.3.1	Creación de la cuenta	69
5.4	Configuración de RF (Receptor - Termostato)	69
5.5	Configuración Wi-Fi (Receptor- Router)	70
5.6	APLICACIÓN CONNECT	71
5.6.1	Modo manual	74
5.6.2	Modo "Programación semanal"	75
5.6.3	Modo Vacaciones	79
5.6.4	Modo Termostato apagado	79
5.7	Termostato	80
5.7.1	Operaciones básicas	80
5.8	Compensación con temperatura externa.	84
5.9	Receptor	85
6.	Características técnicas	86

1. INTRODUCCIÓN

Estimado cliente: gracias por adquirir un termostato Smart CONNECT.

Este dispositivo le permitirá hacer un control preciso de la temperatura ambiente, incluso a distancia mediante una conexión wifi y la aplicación específica.

Este manual está dedicado a los instaladores y usuarios.

El elemento principal del sistema es el cronotermostato, que gestiona los programas horarios configurados con la App, mide la temperatura de zona y transmite los mandos de encendido y apagado a una centralita remota conectada directamente a la caldera.

2. NORMAS GENERALES DE SEGURIDAD

- Lea atentamente las instrucciones contenidas en este manual.
- Una vez terminada la instalación, explique al usuario las funciones del dispositivo y entréguele este manual, que deberá conservar con cuidado por ser parte integrante del producto y para futuras consultas.
- La instalación y el mantenimiento deben ser realizados por un técnico autorizado, en conformidad con las normas vigentes y las instrucciones del fabricante. No realice ninguna operación en los componentes de control precintados.
- Desconecte la alimentación eléctrica antes de limpiar el dispositivo.
- No sitúe el dispositivo cerca de fuentes de calor.
- No deje el dispositivo al alcance de los niños.

3. CATEGORÍA DE CONTROL SEGÚN EL REGLAMENTO ERP

Con referencia al Reglamento Delegado (UE) n.º 811/2013, los datos presentes en la tabla pueden emplearse para completar el etiquetado de aparatos de calefacción.

Combinaciones posibles con CONNECT, clases de configuración respectivas y contribución energética al sistema.

Tipo de caldera	CONNECT	Clase y contribución
Caldera con temperatura de ida fija (On-Off)	Tipo On-Off	I = 1 %
Caldera con temperatura de ida variable (consigna con bus de comunicación)	Conexión mediante bus de comunicación. Set point de ida calculado en base a la temperatura ambiente y exterior.	VI = 4 %
	Conexión mediante bus de comunicación. Consigna de ida calculada en función de al menos 3 temperaturas ambiente (requiere al menos 3 termostatos y 3 válvulas de zona)	VIII = 5 %

4. PARA EL INSTALADOR

4.1 Contenido

La caja contiene los siguientes elementos:



Transmisor
Cronotermostato



Receptor



Manual

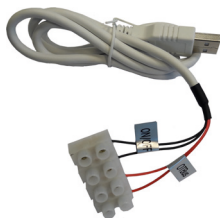

Cable USB



Alimentador

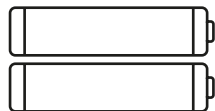

Pilas AAA



Soporte de sobremesa

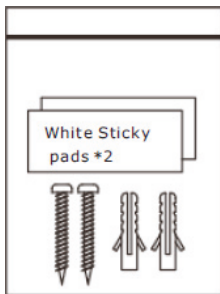

Accesorios

4.2 Instalación del receptor

ATENCIÓN: para proteger el dispositivo, desconecte la alimentación de la caldera antes de hacer la conexión. La operación debe ser realizada por un técnico autorizado.

El receptor puede funcionar con el protocolo OpenTherm o con el contacto On-Off.

Fije el receptor a una superficie adecuada con la placa magnética o el biadhesivo (suministrados con los accesorios) o atorníllelo a la pared.

La pasarela se debe instalar en el interior del edificio, y este no debe estar apantallado por ninguna cubierta metálica.

Opción OpenTherm (A fig. 1): Conecte los dos hilos rojos con etiqueta **OTBus**, procedentes del receptor, a la caldera en la que se ha previsto la conexión **OpenTherm**. Deje desconectados los otros dos hilos. En este caso se visualizan más informaciones sobre el estado de la caldera (ver “5.7.1 Operaciones básicas” en la pág. 80).

Opción On-Off (B fig. 1): Conecte los dos hilos negros con etiqueta **ON/OFF**, procedentes del receptor, a la caldera en la que se ha previsto la conexión al termostato **ON/OFF**. Deje desconectados los otros dos hilos.

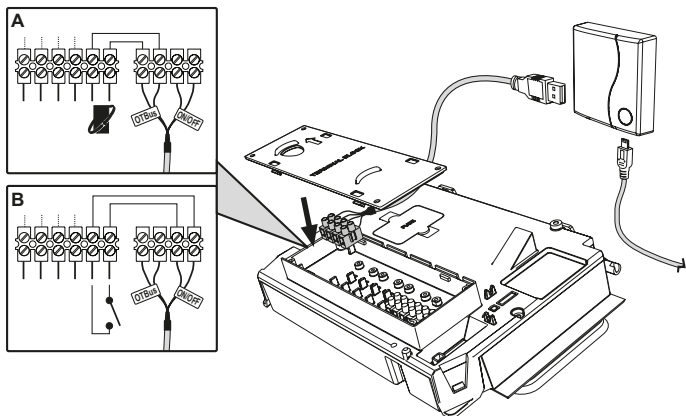

fig. 1

Cuando se conecta la alimentación, los ledes parpadean brevemente.

4.3 Instalación del termostato

Separe COINNECT de la base fig. 2.

Fije la base con los tornillos suministrados fig. 3.

Si el termostato se conecta directamente a la caldera o a una válvula de zona, se deben conectar los cables al borne correspondiente fig. 4.

Coloque dos pilas AAA de 1,5 V fig. 5.

Enganche COINNECT a la base fig. 6.

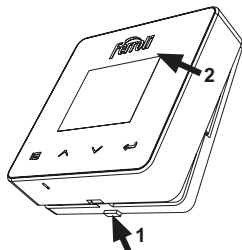

fig. 2

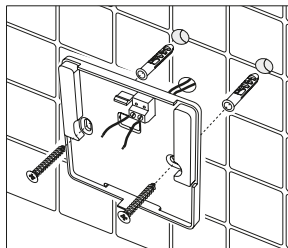

fig. 3

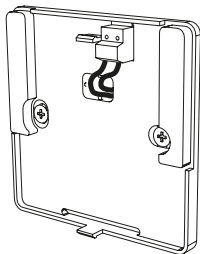

fig. 4

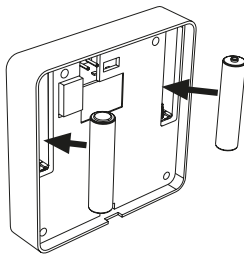

fig. 5

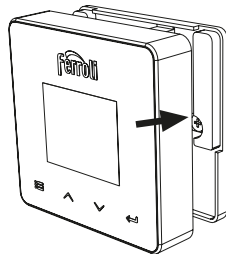

fig. 6

4.4 Montaje del soporte del termostato

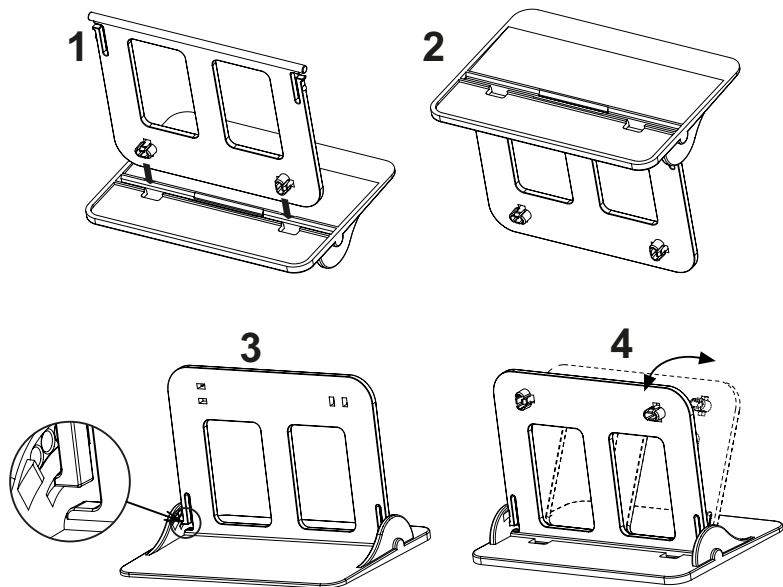

fig. 7 - Soporte del termostato

5. PARA EL USUARIO

5.1 Botones e iconos

A continuación se describen los símbolos que aparecen en la pantalla y el uso de los botones.

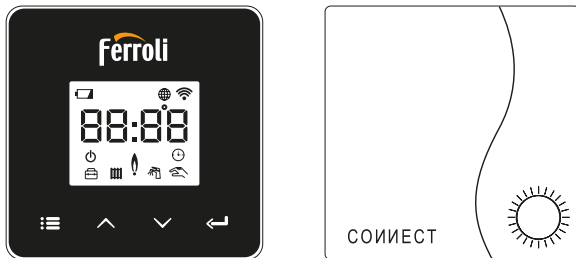

fig. 8

Icono	Descripción
	Calefacción
	Agua sanitaria
	Demanda de calor
	OFF
	Modo AUTO
	Modo MANUAL
	Modo VACACIONES

Icono	Descripción
	Conexión RF
	Conexión wifi
	Bajo nivel de las pilas
	Temperatura y horario
	modo / guardar / salir
	aumentar
	disminuir
	intro
	Botón LED

Pilas: Cuando la carga de las pilas es insuficiente, aparece el icono en la pantalla.

Llama

- » Termostato conectado a una caldera on-off; el icono indica el estado de la demanda.
- » Termostato conectado a una caldera OpenTherm; el icono indica el estado del quemador.

Nota: *en el primer encendido, el termostato se configura automáticamente en el modo de conexión por cable **On-Off**.*

*Cuando el termostato y el receptor wifi se conectan a la red inalámbrica, el termostato se conmuta automáticamente al modo **RF On-Off**.*

*Cuando el receptor wifi se conecta a una caldera OpenTherm, el termostato se conmuta automáticamente al modo **RF OpenTherm**.*

*Si el termostato se ha configurado como RF (On-Off u OpenTherm), no se conmuta automáticamente al modo **cable On-Off**. Para obtener esta función, se deben quitar y volver a colocar las pilas.*

Sanitario: el icono indica que está activada la producción de agua caliente sanitaria.

Nota: *el icono está presente solo en caso de conexión RF con calderas OpenTherm.*

Calefacción: el icono indica que está activada la calefacción.

Nota: *el icono está presente solo en caso de conexión RF con calderas OpenTherm.*

Temperatura: se visualizan la temperatura ambiente o los errores:

E82: *error de comunicación RF*

E83: *error de comunicación OpenTherm*

5.2 Diagrama de funcionamiento

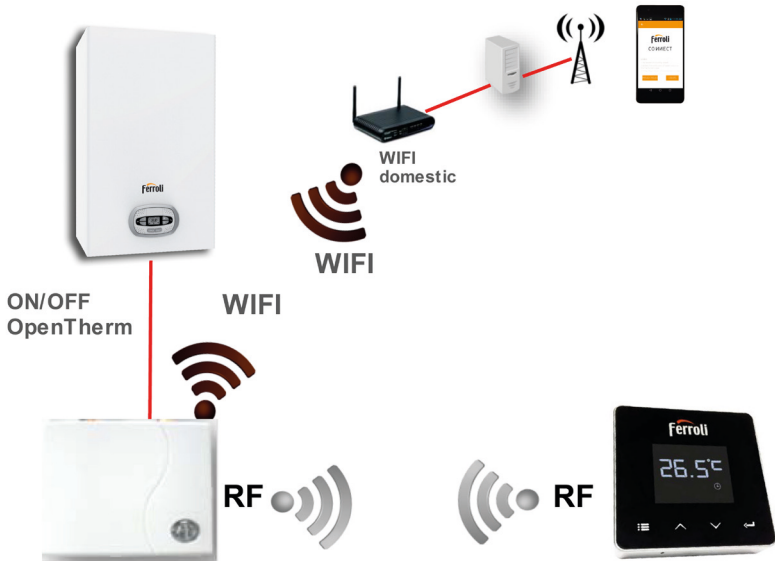

fig. 9

5.3 Configuración del sistema

Para obtener un funcionamiento correcto con su dispositivo (teléfono inteligente o tableta), proceda como se indica a continuación.

- Descargue la aplicación (CONNECT) directamente del App Store de su dispositivo o mediante el código QR impreso en la parte exterior del embalaje.
- Tras la instalación, pase a la creación de la cuenta.





5.3.1 Creación de la cuenta

- Asegúrese de que su dispositivo (teléfono inteligente o tableta) esté conectado a la red wifi.
- Abra la aplicación específica y pulse "Registrar".
- Introduzca los datos solicitados y pulse el botón de verificación del código.
- Para confirmar el registro, introduzca el código recibido por e-mail.

Para controlar la caldera desde distintas unidades de consumo, se debe entrar con la misma cuenta.

5.4 Configuración de RF (Receptor - Termostato)

Para establecer la conexión RF entre el termostato y el receptor, proceda como se indica a continuación.

- Pulse el botón led del receptor hasta que parpadee (alrededor de 7 segundos).
- En el termostato, presione el botón **"intro"**  durante algunos segundos hasta que la pantalla parpadee.
- Pulse el botón  hasta que aparezca **COUP** y pulse entonces el botón **"intro"** .
- Cuando aparece el mensaje **"r01, r02..÷..r08"**, significa que la conexión se ha establecido. Pulse otra vez el botón **"intro"** .

Nota: el intercambio de datos entre el termostato y el receptor se efectúa en el término de 2 minutos.

5.5 Configuración Wi-Fi (Receptor- Router)

Conectarse con el dispositivo Smartphone / Tablet propio a la red Wifi local.

- Hacer clic en “+” e introducir la contraseña de la red local.
- Pulse “continuar” ➞.
- En el receptor pulsar un instante la tecla WPS con la correspondiente herramienta.
- Pulse “continuar” ➞.
- Seguir las instrucciones de la APP.

Si el procedimiento no termina correctamente:

- Controlar la conexión Wifi del dispositivo móvil (la configuración debe efectuarse con Wifi)
- Controlar el router, reiniciar el dispositivo móvil y repetir las operaciones

5.6 APLICACIÓN CONNECT

En la pantalla principal (fig. 10), pulse donde se indica para acceder a la pantalla control de una de las calderas configuradas.

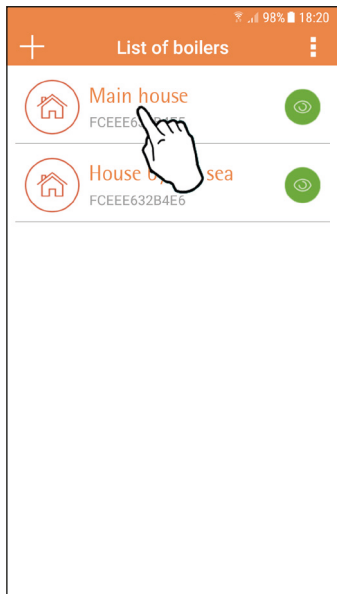

fig. 10 - Pantalla principal

En la pantalla siguiente (fig. 11), pulse **A** para gestionar la termostatación del ambiente o **B** para ver el estado de la caldera.

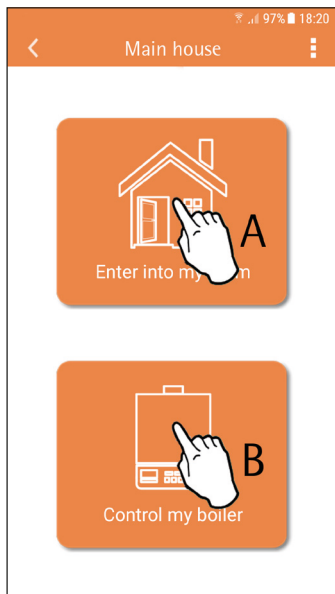

fig. 11 -



Desde esta pantalla se accede a la configuración del cronomando remoto conectado.

Si hay varias zonas, seleccione la deseada.

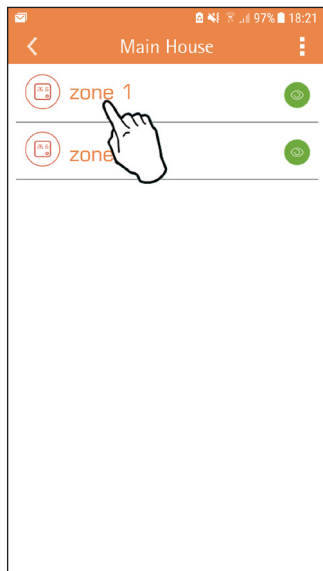

fig. 12 - Control del cronomando

Los modos posibles son:





-  Manual
-  Programación semanal
-  Vacaciones
-  Termostato apagado



fig. 13 - Modos posibles



En esta pantalla (fig. 14), si la caldera está conectada mediante protocolo OpenTherm, es posible visualizar su estado. Además, haciendo clic en los símbolos , es posible cambiar los set points sanitario y calefacción en la caldera.

Si la caldera está conectada mediante contacto On-Off, se visualiza sólo el estado de la solicitud (fig. 15).

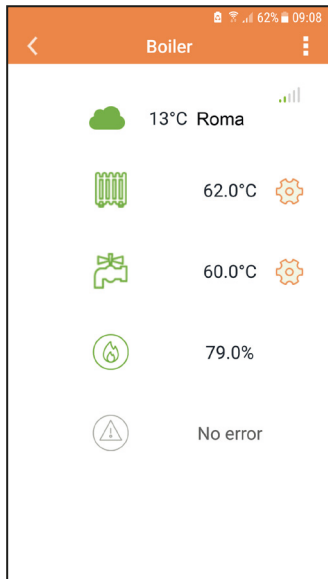

fig. 14 - Con OpenTherm

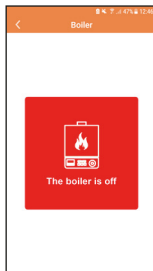
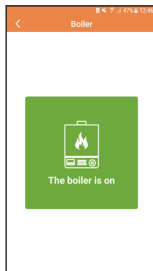

fig. 15 Con termostato de ambiente



5.6.1 Modo manual

En esta modalidad es posible ajustar la temperatura ambiente deseada.

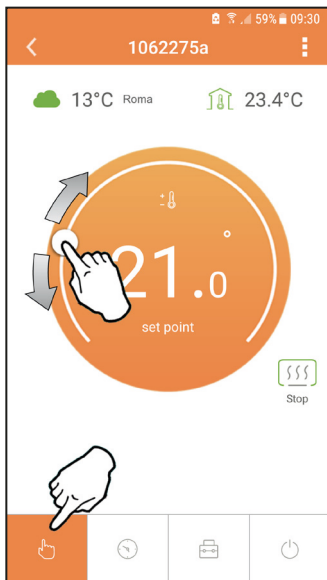

fig. 16

5.6.2 Modo "Programación semanal"

En esta modalidad es posible ajustar la temperatura deseada para las distintas franjas horarias de cada día de la semana pulsando en el punto "B" indicado en fig. 17.

Además, es posible cambiar temporalmente la temperatura deseada (hasta la siguiente franja horaria) actuando en el punto "A", sin modificar el programa.

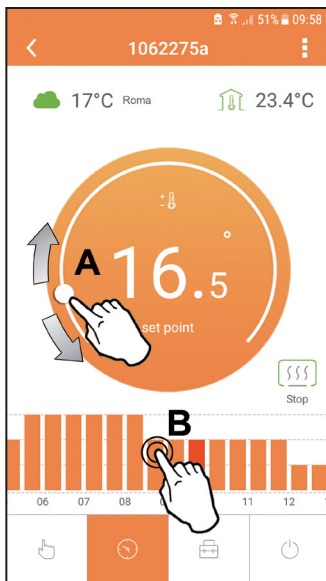

fig. 17

Hay 3 niveles de temperatura: **T3** (Nivel CONFORT 1), **T2** (Nivel CONFORT 2) y **T1** (Nivel ECO).

Para ajustar la temperatura de los niveles **T1**, **T2** y **T3**, proceda como se indica a continuación.

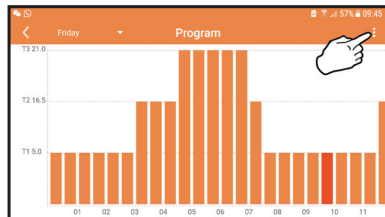

fig. 18

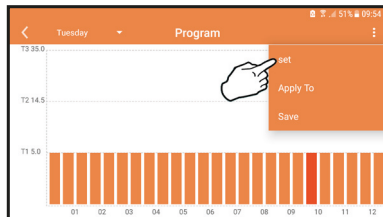

fig. 19

Establezca las temperaturas y confirme.

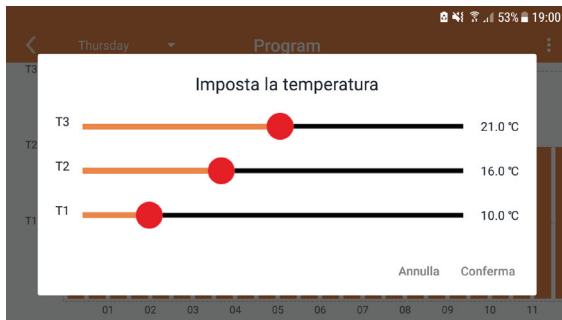

fig. 20 Ajuste de las temperaturas

Para cambiar las franjas horarias, pulse en el área que se desea modificar.

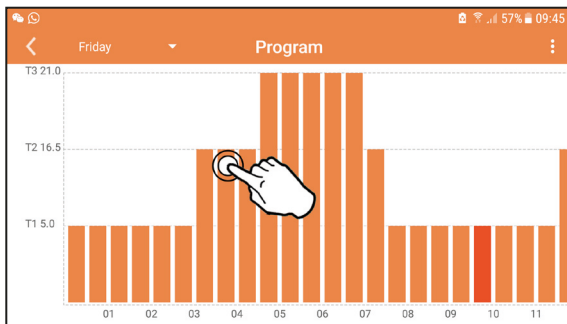

fig. 21

Una vez programadas las temperaturas, guarde la configuración.

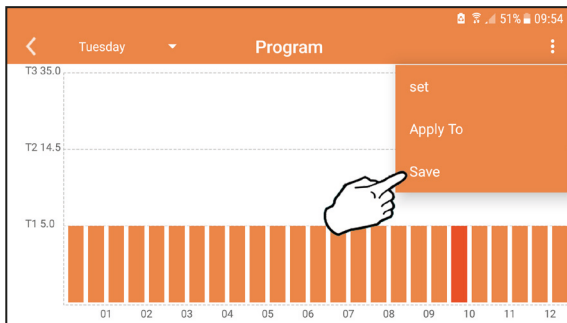

fig. 22

Pulse "aplicar" para seleccionar los días en los cuales desee copiar la configuración recién efectuada.

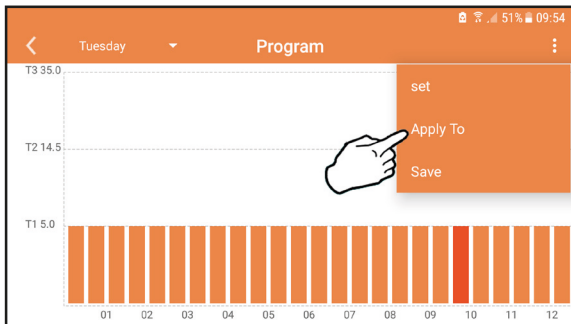



fig. 23

Si está disponible la información de la temperatura exterior (vía web u OpenTherm), la temperatura programada en la caldera tiene en cuenta este valor para regular el envío. Si la temperatura exterior no está disponible, el envío se regula en función de la temperatura ambiente programada.

5.6.3 Modo Vacaciones

En esta modalidad la caldera se apaga y se vuelve a activar si la temperatura cae por debajo del valor de consigna indicado. Pulse el icono de configuración  para programar la fecha de terminación de las vacaciones.

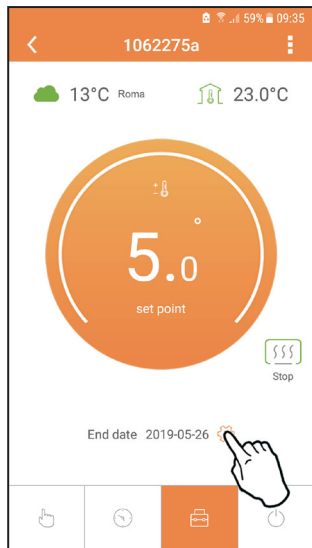

fig. 24

5.6.4 Modo Termostato apagado

En esta modalidad la caldera se apaga, y se vuelve a activar si la temperatura cae por debajo de 5 °C.

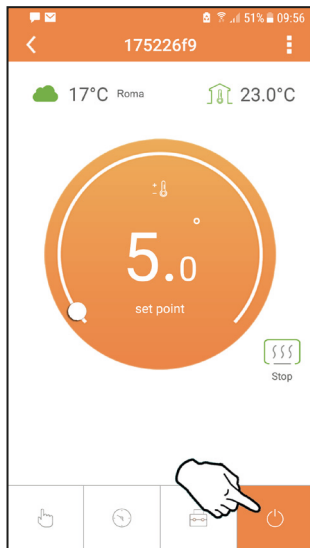

















fig. 25

5.7 Termostato







5.7.1 Operaciones básicas

1. Pulsando el botón **"modo"**  se puede conmutar el funcionamiento entre las distintas opciones:
 - a. **Off** : en esta modalidad la demanda de calor está deshabilitada, permanece activada solo la función antihielo.
 - b. **Vacaciones** : está programada la temperatura de ahorro energético + antihielo por el número de días especificado con los botones  .
 - c. **Automático** : la consigna de temperatura es la del programa semanal, introducida desde la aplicación. Si el programa no se ha configurado, se utilizan los valores de fábrica.
 - d. **Manual** : la temperatura se ajusta a mano, directamente en el termostato.
2. **Ajuste de la temperatura:**
 - a. **Manual:** utilice los botones  .
3. **Menú "configuración":** pulse el botón **"intro"**  durante 2 segundos para entrar en el menú de configuración.
 - a.  y  para desplazar el menú
 - b. **"intro"**  para acceder al parámetro seleccionado
 - c. **"modo"**  para volver al menú principal
4. En caso de una anomalía de la caldera, el código del error aparece también en la pantalla del termostato. El estado de anomalía se puede desbloquear con el botón **"intro"** .









Para la descripción de la anomalía, consulte el manual de la caldera.

N.º	Parámetro	Pantalla	Descripción
1)	Reloj	14:05	Ajuste de horas, minutos, año (y), mes (m) y día (d).
2)	Temperatura	23.0°C	Ajuste de la temperatura de CFT1, CFT2, ECO y FRST
3)	Código COUP	COUP	Código RF (vea el apartado 5.4 en la página 69)
4)	Valor de consigna del agua sanitaria	40.0	Ajuste de temperatura del ACS, disponible solo con conexión OpenTherm
5)	Información de la caldera	INFO	Lectura de algunos parámetros de la caldera, solo con conexión OpenTherm
6)	Datos del instalador	PL	Parámetros de instalador
7)	Salir	EXIT	Volver a la página inicial

1) Reloj

- » Pulse los botones  y  para seleccionar el menú "reloj" y después "intro"  para entrar.
- » Pulse el botón "intro"  para seleccionar el dato que desee cambiar, en este orden: 13:00 hora, 13:42 minutos, 19 y año, 02 m mes, 21 d día.
- » Pulse los botones  y  para cambiar el valor.
- » Pulse "modo"  para volver.







2) Temperatura

- » Pulse los botones  y  para seleccionar el menú "temperatura" y después "intro"  para entrar.
- » Pulse los botones  y  para seleccionar las temperaturas que desee modificar:
- » confort (CF) – economía (EC) – antihielo (FR)
- » Pulse los botones  y  para modificar la temperatura programada.
- » Pulse "intro"  o "modo"  para volver al menú anterior.

3) Código de emparejamiento





- » Vea el apartado 5.4 en la página 69.

4) Temperatura del agua sanitaria (solo calderas OpenTherm)

- » Pulse los botones   para seleccionar la temperatura del agua sanitaria y después "intro"  para entrar.
- » Pulse los botones   para cambiar el valor.
- » Pulse "intro"  o "modo"  para volver al menú anterior.

Nota: si el termostato recibe el dato de la caldera, la pantalla muestra este valor; de lo contrario, el campo de regulación es de 30 – 60 °C.















5) Información de la caldera (solo calderas OpenTherm)

- » Pulse los botones   para seleccionar "información" y después "intro" para entrar.
- » Cuando se visualiza "--" significa que el dato no está disponible en la caldera.
- » Pulse "intro"  o "modo"  para volver al menú anterior.

N.º	información
1	Valor de consigna de ida
2	Sonda de ida
3	Sonda de retorno
4	Temperatura ACS
5	Temperatura exterior
6	Porcentaje de potencia
7	Extracción de ACS
8	Presión instalación

6) Configuración avanzada (PL)

» *Parámetros de instalador*

- » Pulse los botones   para seleccionar el menú “PL” y después “set”  para entrar.
- » Desplácese, con las teclas  , hasta el valor “PS 10” y pulse “set” . Seleccione el parámetro que desea modificar (véase la tabla siguiente) con las teclas   y pulse “set” . Modifique el parámetro elegido utilizando las teclas   y pulse “set”  para confirmar la modificación.
- » Pulse “set”  o “modo”  para volver al menú anterior.

Parám.	Descripción	Step	U.Med.	Predeterminado	Campo
CAU	Calibración sensor ambiente	0.1	°C	Temperatura ambiente	-7 ÷ 7 °C
FRct	Valores fábrica		---	NO	NO - Sí
HOn	Histéresis ON (*)	0.1	°C	0.4	0.0 - 2.0
HOF	Histéresis OFF (**)	0.1	°C	0.1	0.0 - 2.0
bFLt	Duración de la iluminación de la pantalla			08	03 - 15
HHCH	Máximo valor de consigna de ida (***)	1	°C	85	45 - 85 °C
LLCH	Mínimo valor de consigna de ida (***)	1	°C	30	10 - HHCH
CL	Curva climática (***)		---	1.2	0.0, 0.2, 0.4, 0.6, 0.8, 1.0, 1.2, 1.5, 2.0, 2.5, 3.0
HHbO	CH valor de consigna en caldera (***)	1	°C	85 °C	30 - 85 °C
EHt	Salir				

(*) la demanda se activa si la T. amb. < Tset -HOn

(**) la demanda se desactiva si T.amb > Tset + HOF

(***) solo con conexión OpenTherm

7) Salir

» Pulse "intro"  para volver al menú principal.

5.8 Compensación con temperatura externa.

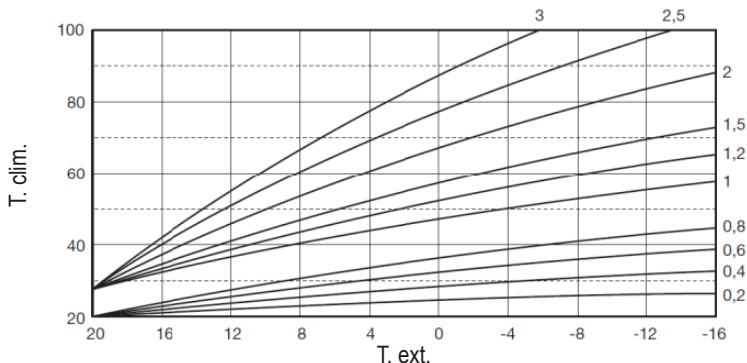

A partir de la temperatura externa (proporcionada por la web o por la sonda conectada a la caldera), el termostato calcula la temperatura de ida de la caldera y, por consiguiente, se optimizan los consumos. Mediante el parámetro CLI (véase menú del instalador PL), se regula la contribución según la fórmula:

$$Tida = T_{clim} + 10 \times CLI \times (T3 - T4)$$

Para deshabilitar la sonda externa, configure CLI = 0; en este caso se obtiene:

$$Tida = LLCH + 10 \times (T3 - T4)$$

T3 = valor de consigna ambiente

T4 = temperatura ambiente

T clim = véase gráfico

LLCH = véase menú del instalador PL

5.9 Receptor

El receptor permite el intercambio de datos entre el termostato y la caldera.
El botón con ledes de colores indica el estado del sistema.

LED Verde	LED Rojo	DESCRIPCIÓN				
Parpadeante lento	Parpadeante lento					
ON	Parpadeante lento					
ON	OFF					
Parpadeante rápido	OFF				Conexión WiFi en curso	
OFF	Parpadeante rápido				Conexión RF en curso	

6. CARACTERÍSTICAS TÉCNICAS

Eléctricas / mecánicas	Alimentación	100 ~ 240 Vca, 50 / 60 Hz
	Consumo	1,2 W
	Salida relé	Contacto seco - 0,25 A – 230 Vca, 2 A - 30 Vcc
	Termostato	90 x 90 x 22 mm
	Receptor	86 x 86 x 21 mm
	Color	Negro y plateado
	Materiales de la carcasa	ABS + aluminio
Sensor de temperatura	incorporado	
Wifi	Estándar wifi	802.11 b/g/n
	Frecuencia wifi	2,412 GHz – 2,484 GHz
	Frecuencia RF	868 MHz [FSK]
	Distancia RF	máx. 40 m en campo libre (*)
	Antena	incorporada
	Seguridad	WEP / WPA - PSK / WPA2 - PSK
	Protocolo	IPv4, TCP
Tipo de red	STA	

() Los obstáculos o muros pueden reducir el alcance de la señal wifi; en tal caso, acerque la pasarela al router o utilice un extensor WiFi.*

1.	Introduction	88
2.	Règles générales de sécurité	88
3.	Classe de contrôle selon le règlement de sécurité ERP	88
4.	Pour l'installateur	89
4.1	Contenu	89
4.2	Installation du récepteur	90
4.3	Installation du thermostat	92
4.4	Montage du support de thermostat	93
5.	Pour l'utilisateur final	94
5.1	Boutons et icônes	94
5.2	Diagramme fonctionnel	96
5.3	Configuration du système	97
5.3.1	Création de compte	97
5.4	Configuration RF (Récepteur - Thermostat)	97
5.5	Configuration Wi-Fi (Récepteur- Routeur)	98
5.6	APP CONNECT	99
5.6.1	Mode manuel	102
5.6.2	Mode « Programmation hebdomadaire »	103
5.6.3	Mode vacances	107
5.6.4	Mode Thermostat éteint	107
5.7	Thermostat	108
5.7.1	Opérations de base	108
5.8	Compensation avec température extérieure.	112
5.9	Récepteur	113
6.	Caractéristiques techniques	114

1. INTRODUCTION

Chère cliente, cher client, merci d'avoir choisi le thermostat smart COMIIECT.

Ce thermostat vous permettra de contrôler avec précision la température ambiante et, grâce à la connectivité Wi-Fi, vous serez en mesure de le gérer à distance via l'application dédiée.

Cette notice s'adresse aussi bien aux installateurs qu'aux utilisateurs finaux.

L'élément principal du système est le chronothermostat qui peut non seulement gérer les programmes horaires programmés via l'application, mais également mesurer la température de zone et envoyer les commandes d'allumage/d'extinction au module de commande (centrale) directement raccordé à la chaudière.

2. RÈGLES GÉNÉRALES DE SÉCURITÉ

- Lire attentivement les instructions contenues dans la présente notice.
- Après l'installation, informez l'utilisateur sur les fonctionnalités du dispositif et lui remettre la présente notice. L'utilisateur devra, en outre, conserver avec soin cette notice pour toute consultation future. La présente notice fait partie intégrante du produit.
- L'installation et l'entretien devront être effectués par un professionnel qualifié conformément aux textes réglementaires et règles de l'art en vigueur, ainsi qu'aux instructions fournies par le constructeur. Ne pas intervenir sur les parties et/ou composants de commande ou contrôle scellés et/ou verrouillés.
- Couper l'alimentation électrique avant d'effectuer une quelconque opération de nettoyage.
- Ne pas positionner le thermostat à proximité de sources de chaleur.
- Tenir le thermostat hors de la portée des enfants.

3. CLASSE DE CONTRÔLE SELON LE RÈGLEMENT DE SÉCURITÉ ERP

Les données indiquées dans le tableau peuvent être utilisées comme complément de l'étiquetage énergétique des dispositifs de chauffage, en référence au règlement délégué (UE) n° 811/2013.

Combinaisons possibles avec COMIIECT, classes de configuration correspondantes et contribution énergétique au système.

Type de chaudière	CONNECT	Classe et contribution
Chaudière avec température de départ fixe (On-Off)	Type On-Off (« tout ou rien »)	I = 1 %
Chaudière avec température de départ variable (point de consigne par bus de communication)	Connexion par bus de communication. Point de consigne départ calculé en fonction de la température ambiante et extérieure.	VI = 4 %
	Connexion par bus de communication. Point de consigne calculé en fonction d'au moins 3 températures ambiantes distinctes (installation nécessaire d'au moins 3 thermostats et 3 vannes de zone)	VIII = 5 %

4. POUR L'INSTALLATEUR

4.1 Contenu

La boîte contient les éléments suivants :



Émetteur
chronothermostat



Récepteur



Notice

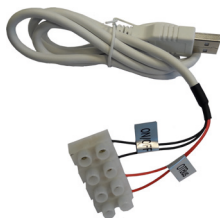

Câble USB



Fiche et câble d'alimentation

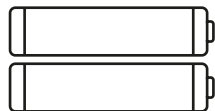

Piles type AAA



Support de table

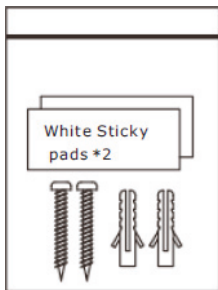

Accessoires

4.2 Installation du récepteur

ATTENTION : coupez l'alimentation électrique de la chaudière avant d'effectuer le raccordement, afin de protéger le dispositif. Cette opération doit être effectuée par un professionnel qualifié.

Le récepteur peut communiquer avec le thermostat soit par protocole OpenTherm, soit par contact On-Off (« tout ou rien »).

Utilisez la plaquette magnétique ou l'adhésif double face, fournis avec les accessoires, pour positionner le récepteur dans l'emplacement le plus adapté suivant la qualité de la surface d'appui, ou bien utilisez les vis pour le fixer directement au mur.

Installer la passerelle à l'intérieur de l'immeuble qui ne devra présenter aucun blindage métallique.

Option OpenTherm (A fig. 1) : Brancher les deux fils rouges étiquetés **OTBus**, provenant du récepteur à la chaudière dotée de la connexion **OpenTherm**. Laisser les deux autres fils débranchés. Dans ce cas, davantage d'informations sur l'état de la chaudière sont disponibles (voir "5.7.1 Opérations de base" page 108.).

Option On-Off (B fig. 1) : Brancher les deux fils noirs étiquetés **ON/OFF**, provenant du récepteur à la chaudière dotée de la connexion au thermostat **ON/OFF**. Laisser les deux autres fils débranchés.

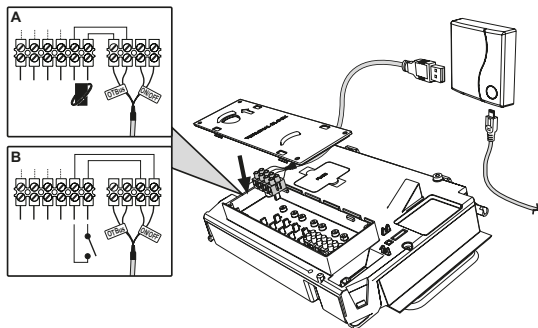

fig. 1

Après la mise sous tension du récepteur, les LED s'allumeront pendant un court instant.

4.3 Installation du thermostat

Séparez CONNECT de la base fig. 2.

Fixez la base à l'aide des vis fournies fig. 3.

Dans le cas d'un thermostat directement raccordé à la chaudière ou à une vanne de zone, connectez les câbles dans la borne de connexion appropriée fig. 4.

Insérez 2 piles de 1,5V type AAA. fig. 5.

Accrochez CONNECT sur la base fig. 6.

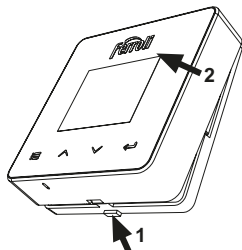

fig. 2

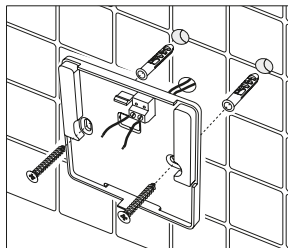

fig. 3

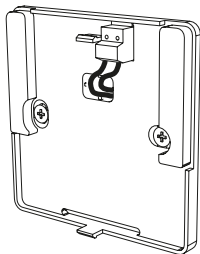

fig. 4

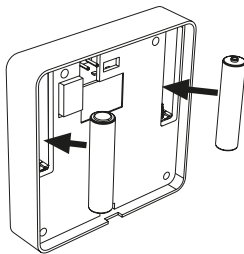

fig. 5

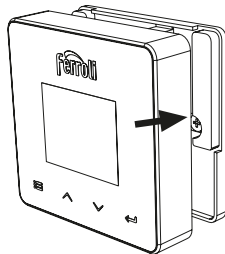

fig. 6

4.4 Montage du support de thermostat

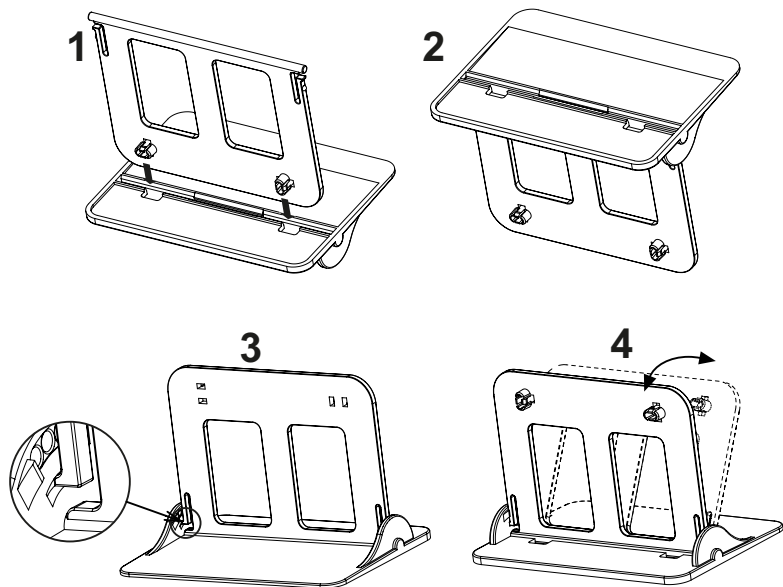

fig. 7 - Support de thermostat

5. POUR L'UTILISATEUR FINAL

5.1 Boutons et icônes

Voici une description des symboles sur l'afficheur et la signification des boutons.

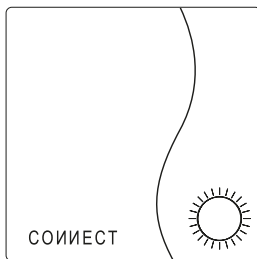

















fig. 8

Icône	Description
	Chauffage
	Sanitaire
	Demande de chaleur
	OFF
	Mode AUTO
	Mode MANUEL
	Mode VACANCES

Icône	Description
	Connexion RF
	Connexion WiFi
	Niveau de charge de la pile faible
	Température et horaire
	mode / sauvegarder / quitter
	augmentation
	diminution
	set (réglage)
	Touche LED

Piles : quand le niveau de charge des piles est insuffisant, l'icône s'active sur l'afficheur.

Flamme

- » Thermostat connecté à une chaudière on-off (« tout ou rien ») : l'icône indique l'état de la demande.
- » Thermostat connecté à une chaudière OpenTherm : l'icône indique l'état du brûleur.
Remarques : le thermostat se configure automatiquement en mode connexion filaire **On-Off** au moment de son premier allumage.

*Quand le thermostat et le récepteur Wifi sont connectés au réseau sans fil, le fonctionnement du thermostat est automatiquement commuté en mode **RF On-Off**.*

*Quand le récepteur Wifi est connecté à une chaudière OpenTherm, le fonctionnement du thermostat est automatiquement commuté en mode **RF OpenTherm**.*

*Si le thermostat est configuré comme RF (on-off ou OpenTherm), son fonctionnement ne commutera pas automatiquement en mode **filaire On-Off**. Ceci ne pourra être fait que si vous enlevez puis remettez en place les piles.*

Sanitaire : l'icône indique que le sanitaire est activé.

Remarques : l'icône n'est présente que dans le cas de liaison RF avec les chaudières OpenTherm.

Chauffage : l'icône indique l'activation du chauffage.

Remarques : l'icône n'est présente que dans le cas de liaison RF avec les chaudières OpenTherm.

Température : l'afficheur montre la température ambiante ou les erreurs ci-dessous :

E82 : erreur de communication RF

E83 : erreur de communication OpenTherm

5.2 Diagramme fonctionnel

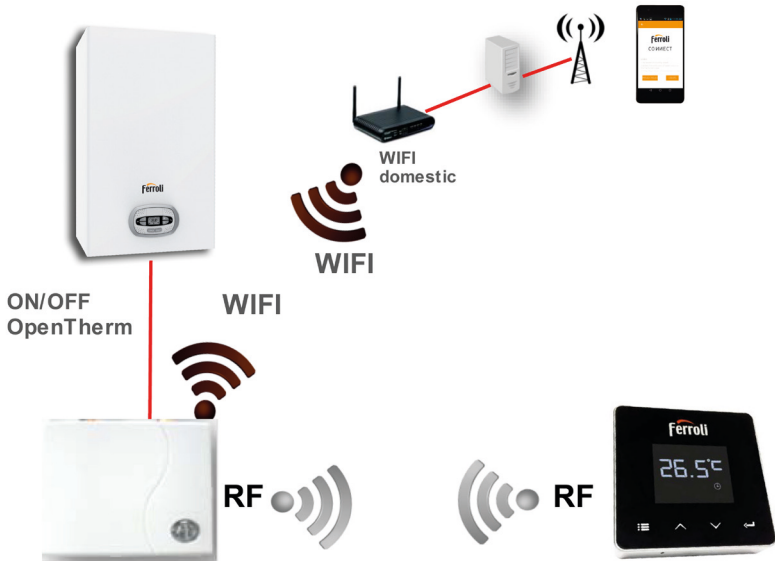

fig. 9

5.3 Configuration du système

Pour permettre le fonctionnement correct du thermostat avec votre dispositif (tablette ou smartphone), suivez impérativement les étapes suivantes :

- Téléchargez l'App (COINTECT) directement depuis l'App Store de votre dispositif ou via le CODE QR figurant sur l'emballage.
- Après l'installation, procédez à la création du compte.





5.3.1 Création de compte

- Assurez-vous que votre dispositif SMARTPHONE/TABLETTE est connecté au réseau Wifi.
- Ouvrez l'APP dédiée, puis cliquez sur « Enregistrer ».
- Saisissez les données qui vous sont demandées et appuyez sur vérification du code.
- Pour confirmer l'enregistrement, saisissez le code que vous avez reçu par mail à l'adresse de courrier électronique saisie précédemment.

Pour commander la chaudière à partir de plusieurs points, accéder à travers le même compte.

5.4 Configuration RF (Récepteur - Thermostat)

Pour établir la liaison radio RF entre le thermostat et le récepteur, suivez les étapes suivantes :

- Appuyez sur la touche LED du récepteur jusqu'à obtenir son clignotement (environ 7 secondes).
- Maintenez enfoncée la touche « set »  pendant quelques secondes sur le thermostat, jusqu'à obtention du clignotement de l'afficheur.
- Appuyez sur la touche  jusqu'à afficher **COUP** et appuyez sur la touche « set » .
- La liaison est établie dès que le message « r01, r02...r08 » s'affiche. Appuyez de nouveau sur la touche « set » .

Remarque : l'échange des données entre thermostat et récepteur a lieu dans les 2 minutes qui suivent.

5.5 Configuration Wi-Fi (Récepteur- Routeur)

Se connecter au réseau wi-fi local à travers le propre dispositif Smartphone / Tablette.

- Cliquer sur « + » et saisir le mot de passe du réseau local
- Appuyer sur « suivant » ➞.
- Appuyer un court instant sur le bouton WPS du récepteur à l'aide d'un outil approprié.
- Appuyer sur « suivant » ➞.
- Suivre les instructions de l'appli

Si la procédure a échoué :

- Vérifier la connexion wi-fi du dispositif mobile (procéder à la configuration en se connectant au réseau wi-fi)
- Vérifier le routeur, remettre le dispositif mobile en marche et répéter les opérations

5.6 APP CONNECT

Sur la page-écran principale (fig. 10), appuyer là indiqué pour accéder au contrôle d'une des chaudières configurées.

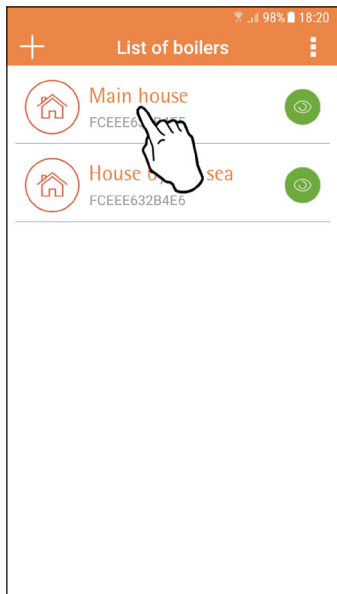

fig. 10 - Écran principal

Sur la page-écran suivante (fig. 11) appuyer **A** pour gérer le réglage thermique ambiant ou appuyer **B** pour afficher l'état de la chaudière.

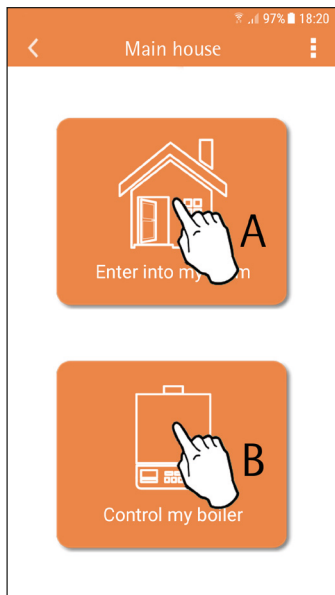

fig. 11 -



Dans cet écran, vous pouvez accéder au paramétrage de la chronocommande à distance connectée.

S'il y a plusieurs zones, sélectionner celle qui vous intéresse.

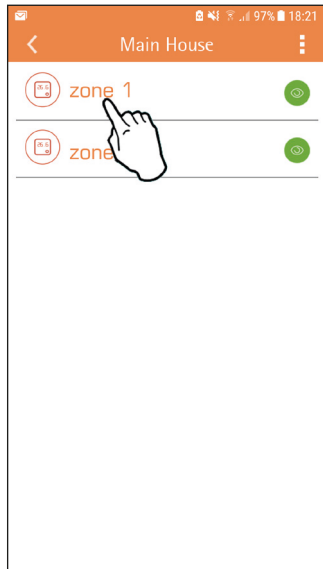





fig. 12 - Gestion chronocommande

Les modes de gestion possibles sont les suivants :

-  Mode manuel
-  Programmation hebdomadaire
-  Mode vacances
-  Thermostat éteint

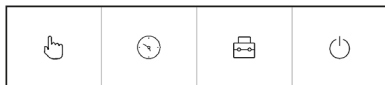



fig. 13 - Modes possibles



Dans cette page-écran (fig. 14), si la chaudière est connectée via le protocole OpenTherm, il est possible d'en afficher l'état. Il est en outre possible, en cliquant sur les symboles , de modifier les points de consigne du sanitaire et du chauffage dans la chaudière.

Si la chaudière est connectée via contact On-Off, seul l'état de la demande sera affiché (fig. 15).

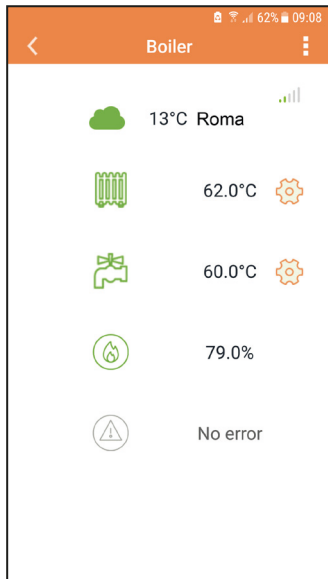

fig. 14 - Avec la technologie OpenTherm

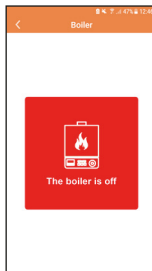
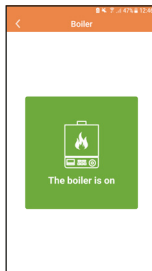

fig. 15 Avec le thermostat d'ambiance



5.6.1 Mode manuel

Ce mode vous permet de programmer la température ambiante désirée.

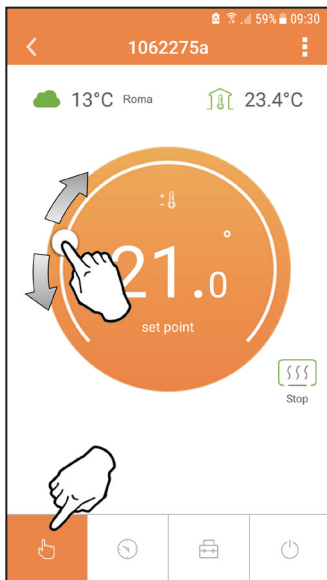

fig. 16

5.6.2 Mode « Programmation hebdomadaire »

Dans ce mode, il est possible de régler la température souhaitée dans les différentes tranches horaires de tous les jours de la semaine en appuyant sur au point “B” indiqué fig. 17.

Il est également possible de modifier temporairement la température souhaitée (jusqu'à la prochaine tranche horaire) en agissant sur le point “A”, sans modifier le programme.

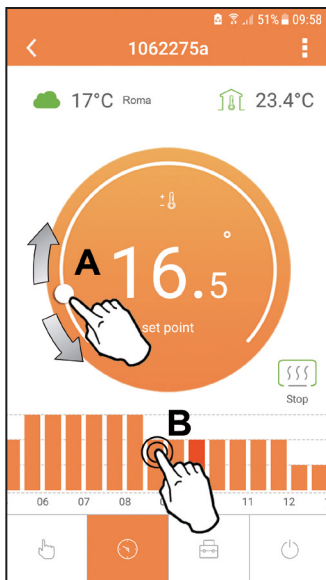

fig. 17

3 niveaux de température sont disponibles : **T3** (niveau CONFORT 1), **T2** (niveau CONFORT 2) e **T1** (niveau ECO).

Pour régler la température des niveaux **T1**, **T2** et **T3**, suivre la séquence indiquée ci-dessous.

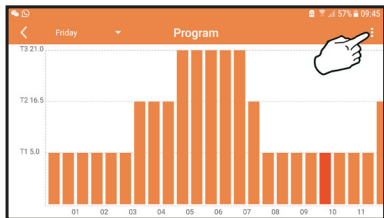

fig. 18

Programmez les températures et confirmez.

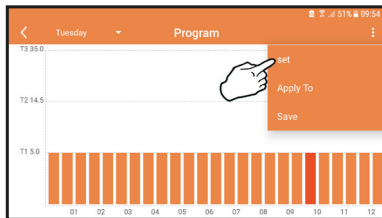

fig. 19

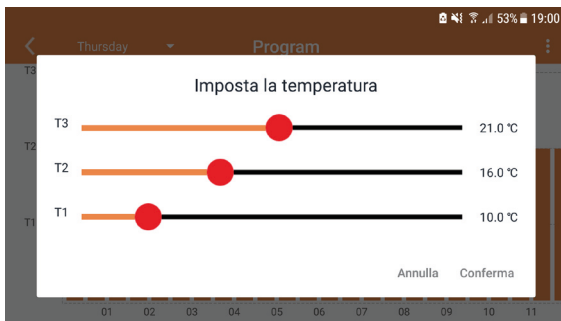

fig. 20 Programmation des températures

Pour modifier les plages horaires, appuyer dans la zone que vous souhaitez modifier.

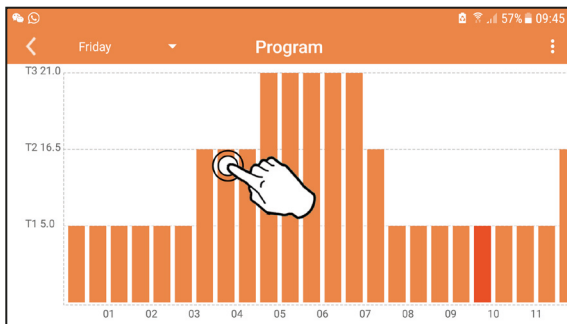

fig. 21

Sauvegardez la configuration après avoir programmé les températures.

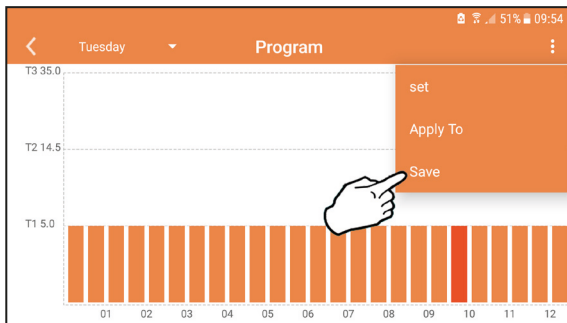

fig. 22

Cliquez sur « appliquer » pour choisir les jours dans lesquels copier la programmation que vous avez effectuée précédemment.

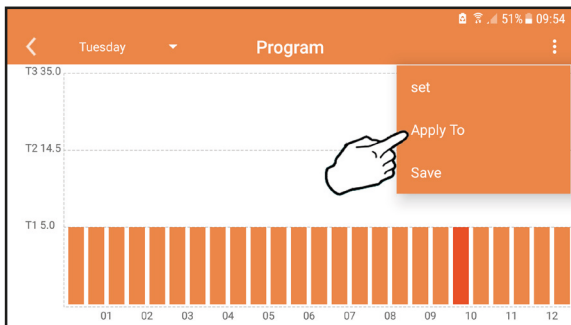



fig. 23

Si les informations de température extérieure sont disponibles (via WEB ou OpenTherm), la température définie dans la chaudière prend en compte cette valeur pour ajuster le débit.
Si la température extérieure n'est pas disponible, le débit est ajusté en fonction de la température ambiante définie.

5.6.3 Mode vacances

Dans ce mode, la chaudière est éteinte et sera réactivée si la température descend en-dessous du point de consigne indiqué.

En appuyant sur l'icône configuration , vous pourrez définir la date de fin des vacances.

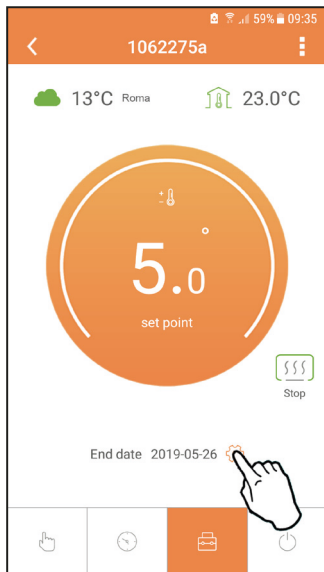

fig. 24

5.6.4 Mode Thermostat éteint

Dans ce mode, la chaudière est éteinte et n'est remise en marche que si la température descend en dessous de 5 °C.

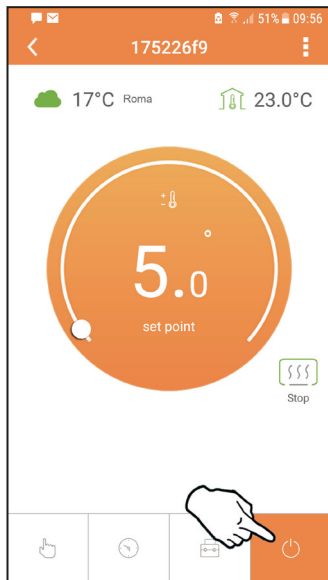

















fig. 25

5.7 Thermostat







5.7.1 Opérations de base

- Appuyez sur la touche **“mode”**  pour basculer entre les différents modes :
 - Off**  : dans ce mode, la demande de chauffage est désactivée. Seul le mode hors gel est activé.
 - Vacances**  : la température programmée correspond à la température d'économie d'énergie hors gel pour un nombre de jours définis via les touches  .
 - Automatique**  : la température requise correspond à la température du programme hebdomadaire programmé via l'application. Le mode par défaut du système sera utilisé si aucun mode n'a été programmé.
 - Manuel**  : la température est réglée manuellement directement sur le thermostat.
- Réglage de la température :**
 - Manuel** : agissez sur les touches  .
- Menu réglages** : appuyez sur la touche **“set”**  pendant environ 2 secondes pour entrer dans le menu réglages :
 - “ et ”** pour parcourir le menu
 - “set”**  permet d'accéder au paramètre sélectionné
 - “mode”**  permet de revenir au menu principal
- Dans le cas d'anomalie de fonctionnement de la chaudière, le code de l'erreur apparaît également sur l'afficheur du thermostat. Vous pouvez débloquer l'anomalie via la touche **“set”** .







Pour la description de l'anomalie, consulter la notice de la chaudière.



N°	Paramètre	Afficheur	description
1)	Horloge	14:05	Permet le réglage des heures, des minutes, de l'année (y), du mois (m), du jour (d).
2)	Température	23.0°C	Règle la température de CFT1, CFT2, ECO, FRST
3)	Code COUP	COUP	Code RF (voir paragraphe 5.4 page 97)
4)	Point de consigne sanitaire	OHU	Permet le réglage de la température du circuit sanitaire ; cette fonction n'est disponible que dans le cas d'une connexion OpenTherm
5)	Informations sur la chaudière	INFO	Lecture de certains paramètres de la chaudière seulement dans le cas d'une connexion OpenTherm
6)	Données de l'installateur	PL	Paramètres pour l'installateur
7)	Quitter	EXIT	Retour à la page initiale

1. Horloge

- » Appuyez sur les boutons  et  pour sélectionner le menu horloge, puis sur **“set”**  pour y accéder.
- » Appuyez sur la touche **“set”**  pour sélectionner les données à modifier avec cette séquence : 13:00 heure, 13:42 minutes, 19 y année, 02 m mois, 21 d jour.
- » Appuyez sur les boutons  et  pour modifier la valeur.
- » Appuyez sur **“mode”**  pour revenir en arrière.

2. Température



- » Appuyez sur les boutons  et  pour sélectionner le menu température, puis sur **“set”**  pour y accéder.
- » Appuyez sur les boutons  et  pour sélectionner les températures à modifier :
- » **comfort** (CF) – **economic** (EE) – **antigel** (FR)
- » Appuyez sur les boutons  et  pour changer la valeur de la température sélectionnée.

» Appuyez sur “set”  ou “mode”  pour revenir au menu précédent.



3. Code de couplage

» Voir paragraphe 5.4 page 97

4. Température ECS (chaudières OpenTherm uniquement)



» Appuyez sur les boutons   pour sélectionner la température sanitaire, puis sur “set”  pour y accéder.

» Appuyez sur les boutons   pour modifier la valeur.



» Appuyez sur “set”  ou “mode”  pour revenir au menu précédent.

Remarque : si la valeur que reçoit le thermostat provient de la chaudière, sur l'afficheur de celui-ci apparaîtra cette même valeur, sans quoi la plage de réglage est 30 – 60 °C.

5. Informations de la chaudière (uniquement les chaudières OpenTherm)

» Appuyez sur les boutons   pour sélectionner le informations, puis sur « set » pour y accéder.













» L'affichage de “-- -” indique que la donnée n'est pas disponible dans le ballon

» Appuyez sur “set”  ou “mode”  pour revenir au menu précédent.

N°	informations
1	Point de consigne refoulement
2	Sonde départ
3	Sonde retour
4	Température sanitaire
5	Température extérieure
6	% de puissance
7	Puisage sanitaire
8	Pression installation

6. Réglages avancés (PL)

» Paramètres pour l'installateur

- » Appuyez sur les boutons   pour sélectionner le menu "PL", puis sur « set »  pour y accéder.
- » Faire défiler, en utilisant les touches  , jusqu'à atteindre la valeur « PS 10 » et appuyer ensuite sur « set » . Sélectionner le paramètre à modifier (voir tableau ci-dessous) à l'aide des touches   et appuyer sur « set » . Modifier le paramètre sélectionné à l'aide des touches   et appuyer ensuite sur « set »  pour valider.
- » Appuyez sur « set »  ou « mode »  pour revenir au menu précédent.

Param	Description	Palier	Unité	Par défaut	Plage
CRU	Calibrage de la sonde d'ambiance	0.1	°C	Température ambiante	-7.0 + 7.0 °C
FR ct	Réinitialisation réglage d'usine		---	NON	NON - OUI
HO n	Hystérésis ON (*)	0.1	°C	0.4	0.0 ÷ 2.0
HO F	Hystérésis OFF (**)	0.1	°C	0.1	0.0 ÷ 2.0
bt Lt	Durée d'éclairage de l'affichage			08	03 ÷ 15
HH CH	Point de consigne départ maximum (***)	1	°C	85	45 ÷ 85 °C
LL CH	Point de consigne départ minimum (***)	1	°C	30	10 - HHCH
CL I	Courbe de chauffe (***)		---	1.2	0.0, 0.2, 0.4, 0.6, 0.8, 1.0, 1.2, 1.5, 2.0, 2.5, 3.0
HH bD	CH point de consigne chaudière (***)	1	°C	85 °C	30 ÷ 85 °C
EXIT	Exit				

(*) la demande est activée si $T. amb < Tset - HO_n$

(**) la demande est désactivée si $T. amb > Tset + HO_F$

(***) uniquement via le protocole de communication OpenTherm

7. Exit

» Appuyez sur “set” ← pour revenir au menu principal.

5.8 Compensation avec température extérieure.

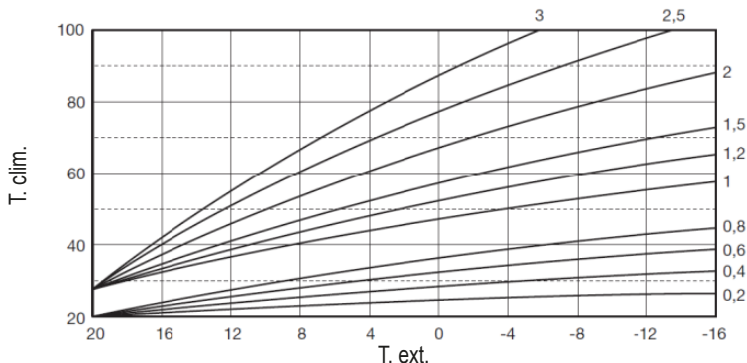

Grâce à la température extérieure (depuis le WEB ou connectée à la chaudière) le thermostat calcule la température départ chaudière en optimisant la consommation. Par le paramètre CLI (voir menu installateur PL), on règle la contribution selon la formule :

$$\text{Trefoulement} = T_{\text{clim}} + 10 \times \text{CLI} \times (T_3 - T_4)$$

Pour désactiver la sonde extérieure, régler CLI = 0. Dans ce cas on a :

$$\text{Trefoulement} = \text{LLCH} + 10 \times (T_3 - T_4)$$

T3 = réglage ambiance





















T4 = temp. ambiance

T clim = voir graphique

LLCH = voir menu installateur PL

5.9 Récepteur

Le récepteur permet l'échange de données entre le thermostat et la chaudière.
L'état du récepteur est indiqué par la LED colorée intégrée.

LED Vert	LED Rouge	DESCRIPTION				
Clignotant lent	Clignotant lent					
ON	Clignotant lent					
ON	OFF					
Clignotant rapide	OFF				Connexion WiFi en cours	
OFF	Clignotant rapide				Connexion RF en cours	

6. CARACTÉRISTIQUES TECHNIQUES

Électriques/ mécaniques	Alimentation	100 ~ 240 Vca, 50 / 60 Hz
	Consommation	1,2 W
	Sortie relais	Contact sec - 0,25 A – 230 Vca, 2A - 30 Vcc
	Thermostat	90 x 90 x 22 mm
	Récepteur	86 x 86 x 21 mm
	Coloris	Noir + argent
	Boîtier	ABS + aluminium
	Sonde de température	intégrée
Wi-Fi	Standard Wi-Fi	802.11 b/g/n
	Fréquence Wi-Fi	2.412 GHz – 2.484 GHz
	Fréquence RF	868 MHz [FSK]
	Portée RF	max 40 m en champ libre (*)
	Antenne	intégrée
	Sécurité	WEP / WPA - PSK / WPA2 - PSK
	Protocole	IPv4, TCP
Type de réseau	STA	

() Tout obstacle ou mur risque de réduire la portée du signal Wi-Fi. Dans ce cas, approcher la passerelle du routeur ou utiliser une extension Wi-Fi.*

1.	Prezentare	116
2.	Norme generale de siguranță	116
3.	Clasa de control conform regulamentului ErP	116
4.	Pentru instalator	117
4.1	Conținut	117
4.2	Instalarea receptorului	118
4.3	Instalarea termostatului	120
4.4	Montarea suportului termostatului	121
5.	Pentru utilizatorul final	122
5.1	Butoane și pictograme.....	122
5.2	Diagramă funcțională.....	124
5.3	Configurarea sistemului.....	125
5.3.1	Crearea contului.....	125
5.4	Configurarea RF (Receptor - Termostat).....	125
5.5	Configurarea Wi-Fi (Receptor - Router).....	126
5.6	APLICAȚIA CONIECT	127
5.6.1	Modul manual.....	130
5.6.2	Modul „Programare săptămânală”	131
5.6.3	Modul vacanță.....	135
5.6.4	Modul Termostat oprit.....	135
5.7	Termostat.....	136
5.7.1	Operații de bază.....	136
5.8	Compensarea cu temperatura externă.....	140
5.9	Receptor	141
6.	Specificații tehnice	142

1. PREZENTARE

Stimate client, vă mulțumim că ați ales termostatul inteligent COMECT.

Acesta vă va permite să controlați cu precizie temperatura ambiantă și, datorită conectivității Wi-Fi, poate fi controlat de la distanță prin aplicația specială.

Acest manual este destinat instalatorilor și utilizatorilor finali.

Elementul principal al sistemului este cronotermostatul care poate gestiona programele orare setate de aplicație, poate măsura temperatura zonei și poate trimite comenzile de pornire/oprire la unitatea de comandă de la distanță, conectată direct la centrală.

2. NORME GENERALE DE SIGURANȚĂ

- Citiți cu atenție instrucțiunile din acest manual.
- După instalare, informați utilizatorul în legătură cu funcționarea dispozitivului și lăsați-i această broșură, care va trebui să fie păstrată cu grijă, deoarece constituie o parte integrantă a produsului, pentru a putea fi folosită pe viitor ca referință.
- Instalarea și întreținerea trebuie să fie efectuate de personal specializat și calificat, în conformitate cu normele în vigoare și cu instrucțiunile producătorului. Nu efectuați nicio operațiune asupra pieselor de control sigilate.
- Deconectați de la alimentarea cu electricitate înainte de curățare.
- Nu plasați dispozitivul în apropierea surselor de căldură.
- A nu se lăsa la îndemâna copiilor.

3. CLASA DE CONTROL CONFORM REGULAMENTULUI ERP

În conformitate cu Regulamentul delegat (UE) Nr. 811/2013, datele indicate în tabel pot fi utilizate ca o completare a etichetelor aparatelor de încălzire.

Combinățiile posibile cu COMECT, clasele corespunzătoare de configurare și contribuția energetică la sistem.

Tipul de centrală	СОИИЕСТ	Clasa și contribuția
Centrală cu temperatură fixă în tur (On-Off)	Tip On-Off	I = 1%
Centrală cu temperatură variabilă în tur (valoare setată cu magistrala de comunicație)	Conectare prin magistrala de comunicare. Valoarea setată pentru tur este calculată în funcție de temperatura ambiantă și de cea externă.	VI = 4%
	Conectare prin magistrala de comunicare. Valoarea setată pentru tur este calculată în funcție de cel puțin 3 temperaturi ambiante diferite (sunt necesare cel puțin 3 termostate și 3 supape pentru zone)	VIII = 5%

4. PENTRU INSTALATOR

4.1 Conținut

Cutia conține următoarele componente:



Transmițător
cronotermostat



Receptor



Manual



Cablu USB



Alimentator

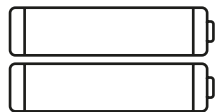

Baterii tip AAA



Suport de masă

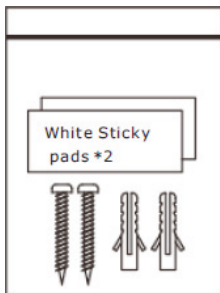

Accesorii

4.2 Instalarea receptorului

ATENȚIE: decuplați alimentarea cu electricitate a centralei înainte de a efectua conexiunea, pentru a proteja dispozitivul. Operațiunea trebuie să fie efectuată de personal specializat.

Receptorul poate funcționa cu protocolul OpenTherm sau cu contactul On-Off.

Utilizați plăcuța magnetică sau banda biadezivă, furnizate ca accesorii, pentru a poziționa

ona receptorul în cea mai potrivită poziție, în funcție de calitatea suprafeței, sau utilizați șuruburile pentru a-l fixa direct pe perete.

Gateway-ul trebuie să fie instalat în interiorul clădirii; acesta nu trebuie să fie ecranat de eventuale carcase metalice.

Opțiunea OpenTherm (A fig. 1): Conectați cele două cabluri roșii cu eticheta **OTBus**, care provin de la receptor, la centrala pe care este prevăzută conexiunea **OpenTherm**. Lăsați deconectate celelalte două cabluri. În acest caz, aveți la dispoziție mai multe informații despre starea centralei (vezi „5.7.1 Operații de bază” la pag. 136).

Opțiunea On-Off (B fig. 1): Conectați cele două cabluri negre, cu eticheta **ON/OFF**, care provin de la receptor, la centrala pe care este prevăzută conexiunea la termostatul **ON/OFF**. Lăsați deconectate celelalte două cabluri.

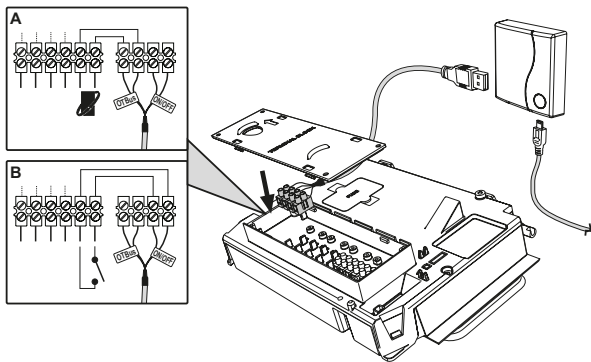

fig. 1

După cuplarea alimentării cu electricitate, ledurile clipesc timp de o clipă.

4.3 Instalarea termostatului

Desprindeți COIINECT de bază fig. 2.

Fixați baza folosind șuruburile din dotare fig. 3.

În cazul în care termostatul este conectat direct la centrală sau la o supapă pentru zonă, este necesar să conectați cablurile la borna corespunzătoare fig. 4.

Introduceți 2 baterii de 1,5V tip AAA fig. 5.

Fixați COIINECT pe bază fig. 6.

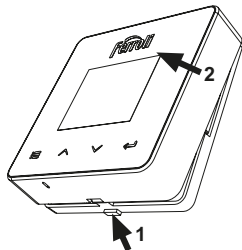

fig. 2

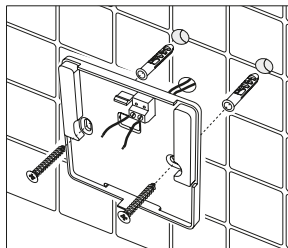

fig. 3

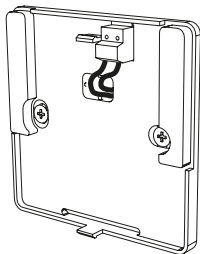

fig. 4

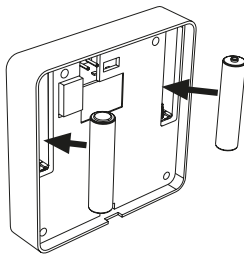

fig. 5

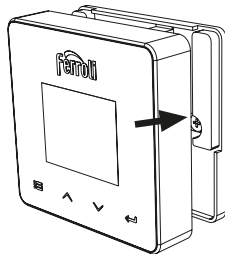

fig. 6

4.4 Montarea suportului termostatului

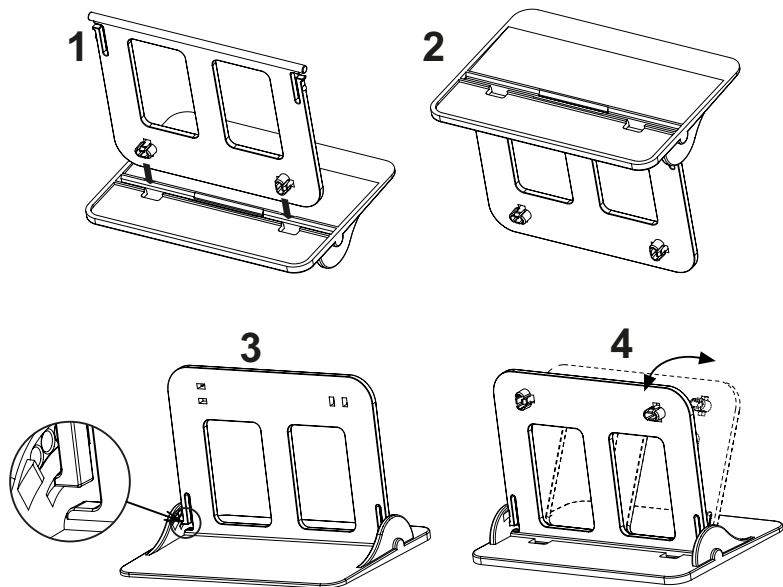

fig. 7 - Suportul termostatului

5. PENTRU UTILIZATORUL FINAL

5.1 Butoane și pictograme

În continuare găsiți o descriere a simbolurilor afișate pe ecran și a semnificației butoanelor.

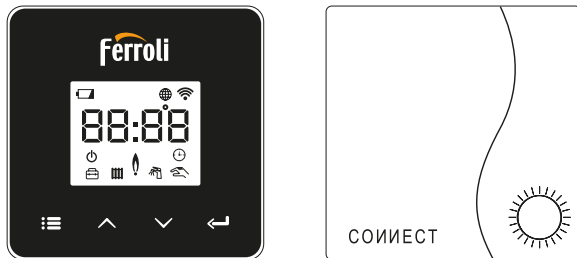

















fig. 8

Pictogramă	Descriere
	Încălzire
	Apă caldă menajeră
	Cerere de căldură
	OFF
	Modul AUTOMAT
	Modul MANUAL
	Modul VACANȚĂ

Pictogramă	Descriere
	Conexiune RF
	Conexiune WiFi
	Nivel scăzut al bateriei
	Temperatură și orar
	mod/salvare/ieșire
	mărire
	reducere
	set
	Tastă Led

Baterie: Când nivelul bateriei este insuficient, se activează pictograma de pe ecran.

Flacăra

- » Termostat conectat la o centrală on-off, pictograma indică starea solicitării.
- » Termostat conectat la o centrală OpenTherm, pictograma indică starea arzătorului.

Notă: la prima pornire, termostatul se configurează automat în modul de conectare prin cablu **On-Off**.

*Când termostatul și receptorul Wifi sunt conectate la rețeaua wireless, termostatul se comută automat pe modul **RF On-Off**.*

*Când receptorul Wifi este conectat la o centrală OpenTherm, termostatul se comută automat pe modul **RF OpenTherm**.*

*Dacă termostatul este configurat ca RF (on-off sau OpenTherm), nu se comută automat pe modul **cablu On-Off**. Acest lucru se poate face numai prin scoaterea și punerea la loc a bateriilor.*

Apă caldă menajeră: pictograma indică faptul că circuitul de apă caldă menajeră este activ.

Notă: pictograma apare numai în cazul conexiunii RF cu centrale OpenTherm.

Încălzire: pictograma indică faptul că încălzirea este activă.

Notă: pictograma apare numai în cazul conexiunii RF cu centrale OpenTherm.

Temperatură: se afișează temperatura ambiantă sau erorile:

E82: eroare de comunicare RF

E83: eroare de comunicare OpenTherm

5.2 Diagramă funcțională

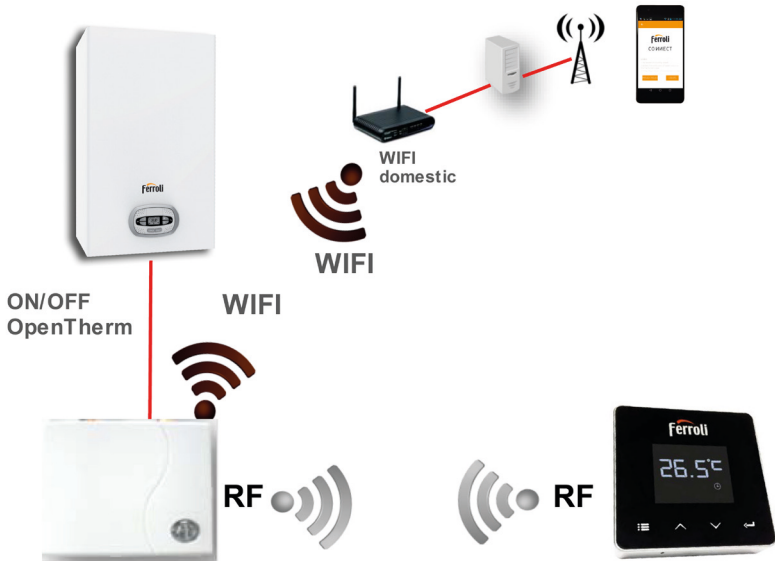

fig. 9

5.3 Configurarea sistemului

Pentru a permite o funcționare corectă cu dispozitivul dv. (tabletă sau smartphone), este necesar să urmați acești pași:

- Descărcați Aplicația (COИECT) direct din App Store de pe dispozitivul dvs. sau utilizând QR CODE aflat la exteriorul ambalajului.
- După instalare, continuați cu crearea contului.





5.3.1 Crearea contului

- Asigurați-vă că dispozitivul dv. SMARTPHONE/TABLETĂ este conectat la rețeaua Wifi.
- Deschideți Aplicația dedicată și faceți clic pe „Înregistrare”.
- Introduceți datele solicitate și apăsați pe Verificare cod.
- Pentru a confirma înregistrarea, introduceți codul primit la adresa de e-mail pe care ați introdus-o anterior.

Pentru ca centrala să poată fi gestionată de mai mulți utilizatori, intrați cu același cont.

5.4 Configurarea RF (Receptor - Termostat)

Pentru a stabili conexiunea RF între termostat și receptor, efectuați următorii pași:

- Apăsați tasta cu led a receptorului până când începe să clipească intermitent (aproximativ 7 secunde).
- Pe termostat țineți apăsată tasta „set”  timp de câteva secunde, până când afișajul începe să clipească intermitent.
- Apăsați tasta  până când se vede  și apăsați pe tasta „set” .
- Când apare mesajul „r01, r02...r08”, înseamnă că s-a realizat conectarea. Apăsați din nou tasta „set” .

Notă: schimbul de date între termostat și receptor se produce în interval de 2 minute

5.5 Configurarea Wi-Fi (Receptor - Router)

Conectați-vă cu dispozitivul dvs. Smartphone / Tabletă la rețeaua WiFi locală.

- Faceți clic pe „+” și introduceți parola rețelei locale.
- Apăsați pe „următorul” ➞.
- Pe receptor apăsați timp de o clipă pe butonul WPS cu unealta respectivă.
- Apăsați pe „următorul” ➞.
- Urmați instrucțiunile din aplicație.

Dacă procedura nu s-a efectuat cu succes:

- Controlați conexiunea WiFi a dispozitivului mobil (configurarea trebuie să fie făcută cu WiFi).
- Controlați routerul, reporniți dispozitivul mobil și repetați operațiunile.

5.6 APLICAȚIA CONNECT

De pe ecranul principal (fig. 10), apăsați unde se indică, pentru a accesa controlul uneia dintre centralele configurate.

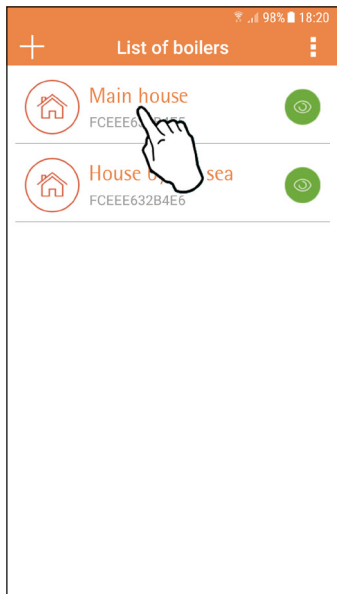

fig. 10 - Ecranul principal

Pe ecranul următor (fig. 11), apăsați **A** pentru a gestiona termoreglarea încăperii sau apăsați **B** pentru a vedea starea centralei.

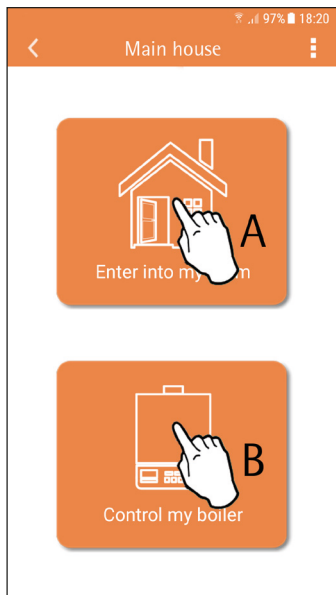

fig. 11 -



Pe acest ecran puteți intra în setarea pentru cronocomanda la distanță conectată.

Dacă există mai multe zone, selectați-o pe cea relevantă.

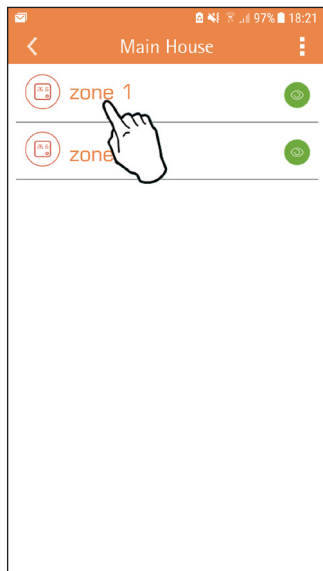





fig. 12 - Controlul cronocomenzii

Modurile posibile sunt:

 Modul manual

 Programare săptămânală

 Modul vacanță



 Termostat oprit



fig. 13 - Moduri posibile



Pe acest ecran (fig. 14), dacă centrala este conectată prin protocolul Open-Therm, se poate afișa starea acesteia. În plus, făcând clic pe simbolurile , se pot schimba valorile setate pentru apa caldă menajeră și pentru încălzire în centrală.

Dacă centrala este conectată prin contact On-Off, se afișează doar starea cererii (fig. 15).

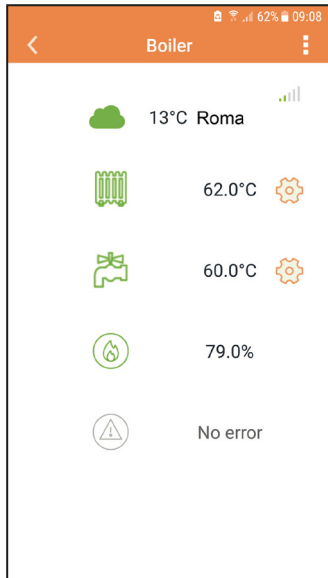

fig. 14 - Cu OpenTherm

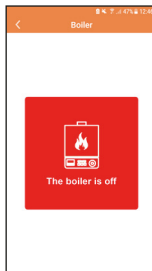
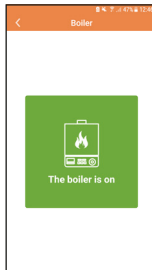

fig. 15 Cu Termostat de cameră



5.6.1 Modul manual

În cadrul acestui mod se poate seta temperatura ambiantă dorită.

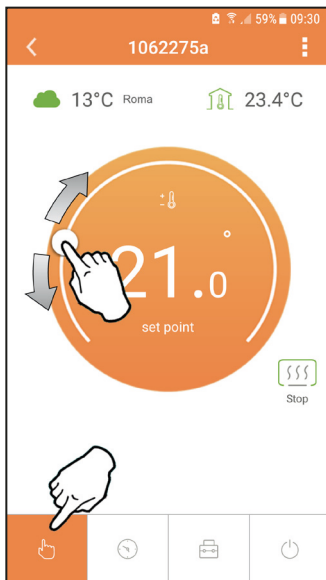

fig. 16

5.6.2 Modul „Programare săptămânală”

În cadrul acestui mod se poate seta temperatura dorită în diferitele intervale de timp ale tuturor zilelor săptămânii, apăsând pe punctul “B” indicat în fig. 17.

În plus, este posibil să se schimbe temporar temperatura dorită (până la următorul interval orar) acționând asupra punctului “A”, fără a modifica programul.

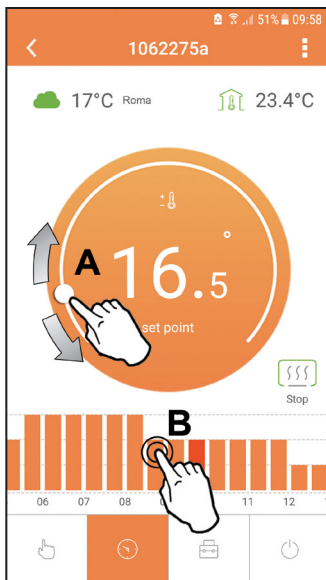

fig. 17

Aveți la dispoziție 3 niveluri de temperatură: **T3** (Nivelul CONFORT 1), **T2** (Nivelul CONFORT 2) și **T1** (Nivelul ECO).

Pentru a seta temperatura nivelurilor **T1**, **T2** și **T3**, urmați secvența de mai jos.

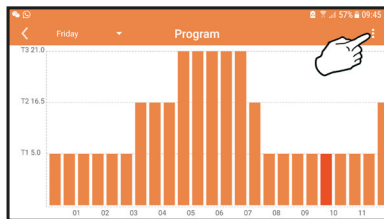

fig. 18

Setați temperaturile și confirmați.

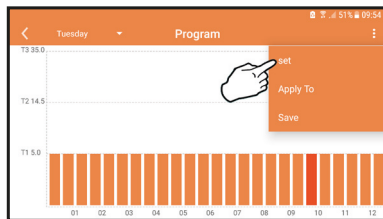

fig. 19

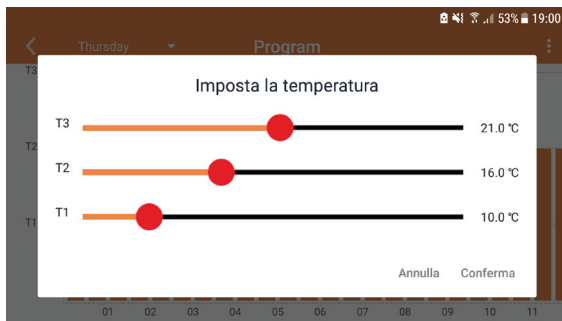

fig. 20 Setarea temperaturilor

Pentru a schimba intervalele orare, apăsați în zona pe care doriți s-o modificați.

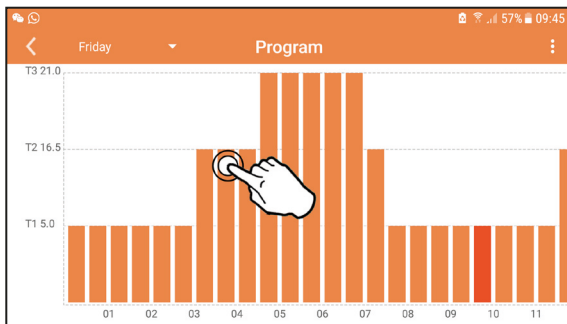

fig. 21

După ce ați programat temperaturile, salvați configurația.

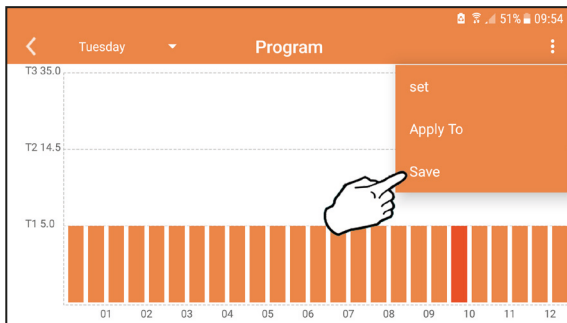

fig. 22

Faceți clic pe „aplicare” pentru a alege zilele în care să copiați setările pe care tocmai le-ați efectuat.

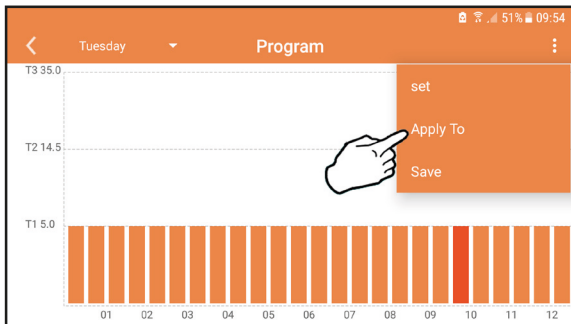



fig. 23

Dacă sunt disponibile informații despre temperatura externă (prin WEB sau prin Open-Therm), temperatura setată în centrală ține cont de această valoare pentru a regla turul: Dacă temperatura externă nu este disponibilă, turul este reglat în funcție de temperatura ambiantă setată.

5.6.3 Modul vacanță

În cadrul acestui mod, centrala este oprită și va fi reactivată în cazul în care temperatura scade sub valoarea setată indicată. Apăsând pe pictograma de setare , se va putea seta data de terminare a vacanței.

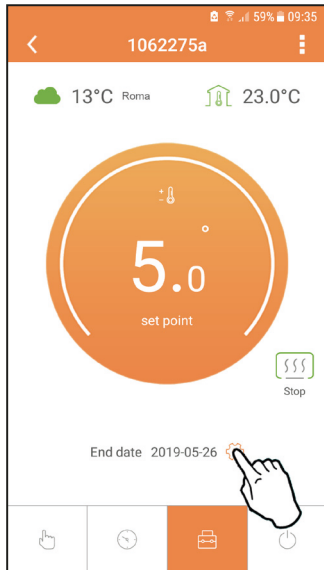

fig. 24

5.6.4 Modul Termostat oprit

În cadrul acestui mod, centrala este oprită și va fi reactivată în cazul în care temperatura scade sub 5°C.

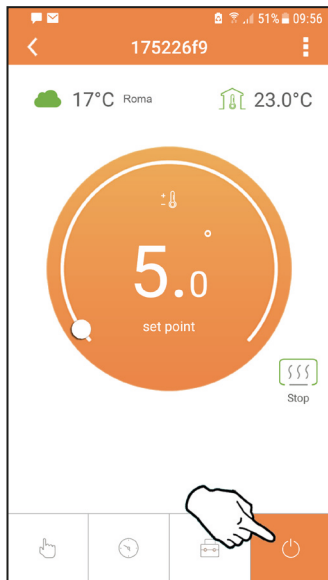















fig. 25

5.7 Termostat







5.7.1 Operații de bază

1. Apăsând tasta „**mode**”  puteți comuta între diferitele moduri:
 - a. **Off** : în cadrul acestui mod, cererea de căldură este dezactivată și rămâne activ numai modul antiîngheț.
 - b. **Vacanță** : temperatura setată este cea pentru economie de energie antiîngheț, pentru un număr de zile setat cu ajutorul tastelor  .
 - c. **Automat** : temperatura cerută este aceea din programul săptămânal setat prin intermediul aplicației. Dacă programul nu a fost setat, se utilizează programul implicit al sistemului.
 - d. **Manual** : temperatura este setată manual direct pe termostat.
2. **Setarea temperaturii:**
 - a. **Manual**: cu ajutorul tastelor  .
3. **Meniul Setări**: apăsând butonul „**set**”  timp de aproximativ 2 secunde, intrați în meniul de setări.
 - a. Cu „ și  se intră în parametrul selectat
 - c. Cu „**mode**”  se revine la meniul principal
4. În cazul unei anomalii a centralei, este indicat codul de eroare și pe afișajul termosta-
tului. Este posibil să se deblocheze anomalia cu ajutorul tastei „**set**” .









Pentru o descriere a anomaliei, consultați manualul centralei.

Nr.	Parametru	Afisaaj	descriere
1)	Ceasul	14:05	Setează orele, minutele, anul (y), luna (m), ziua (d).
2)	Temperatura	23.0°C	Setează temperatura pentru CFT1, CFT2, ECO, FRST
3)	Cod COUP	COUP	Cod RF (vezi paragraful 5.4 la pagina 125)
4)	Valoare setată apă caldă menajeră	40.0°C	Setează temperatura apei calde menajere, funcție disponibilă numai cu conexiune OpenTherm
5)	Informații centrală	INFO	Citirea unor parametri ai centralei, numai cu conexiune OpenTherm
6)	Date instalator	PL	Parametri pentru instalator
7)	Ieșire	EXIT	Revenire la pagina inițială

1) Ceasul

- » Apăsați butoanele  și  pentru a selecta meniul Ceas și apoi „set”  pentru a intra.
- » Apăsând tasta „set” , se selectează data care trebuie schimbată, în această ordine: 13:00 oră, 13:42 minute, 19 9 an, 02 1 lună, 21 d zi.
- » Apăsați butoanele  și  pentru a schimba valoarea.
- » Apăsați „mode”  pentru a reveni.







2) Temperatura

- » Apăsați butoanele  și  pentru a selecta meniul Temperatură și apoi „set”  pentru a intra.
- » Apăsați butoanele  și  pentru a selecta temperaturile care trebuie modificate:
- » confort (CF 1) – economic (EC 2) – antiîngheț (FR 1)
- » Apăsați butoanele  și  pentru a modifica valoarea temperaturii alese.
- » Apăsați „set”  sau „mode”  pentru a reveni la meniul anterior.





3) Cod de cuplare

- » Vezi paragraful 5.4 la pagina 125.

4) Temperaturile pentru apa caldă menajeră (numai centrale OpenTherm)

- » Apăsăți butoanele   pentru a selecta temperatura apei calde menajere și apoi „set”  pentru a intra.
- » Apăsăți butoanele   pentru a schimba valoarea.
- » Apăsăți „set”  sau „mode”  pentru a reveni la meniul anterior.
Notă: dacă termostatul primește datele de la centrală, atunci afișează această valoare, în caz contrar intervalul de setare este de 30 – 60°C.















5) Informații de la centrală (numai centrale OpenTherm)

- » Apăsăți butoanele   pentru a selecta Informații și apoi „set” pentru a intra.
- » Atunci când se afișează „- - -” înseamnă că datele nu sunt disponibile în boiler
- » Apăsăți „set”  sau „mode”  pentru a reveni la meniul anterior.

Nr.	informație
1	Valoare setată tur
2	Sondă tur
3	Sondă retur
4	Temperatură apă caldă menajeră
5	Temperatură externă
6	Procent de putere
7	Preluare apă caldă menajeră
8	Presiune instalație

6) Setări avansate (PL)

» Parametri pentru instalator

- » Apăsați butoanele   pentru a selecta meniul „PL” și apoi „set”  pentru a intra.
- » Derulați, folosind tastele  , până când ajungeți la valoarea „PS 10”, și apoi apăsați „set” . Selectați parametrul de modificat (vezi tabelul de mai jos) folosind tastele   și apăsați „set” . Modificați parametrul ales folosind tastele   și apoi apăsați „set”  pentru a confirma modificarea.
- » Apăsați „set”  sau „mode”  pentru a reveni la meniul anterior.

Parametru	Descriere	Step	Unitate	Implicit	Interval
CLL	Calibrare senzor ambiental	0.1	°C	Temperatura ambientă	-7.0 + 7.0 °C
FRct	Resetare la valorile din fabricație		---	NO	NO - YES
HO _n	Curbă histerezis ON (activată) (*)	0.1	°C	0.4	0.0 ÷ 2.0
HO _F	Curbă histerezis OFF (dezactivată) (**)	0.1	°C	0.1	0.0 ÷ 2.0
btLt	Durata de iluminare a afișajului			08	03 ÷ 15
HHCH	Valoare setată max. pentru tur (***)	1	°C	85	45 ÷ 85°C
LLCH	Valoare setată min. pentru tur (***)	1	°C	30	10 - HHCH
CLl	Curbă climatică (***)		---	1.2	0.0, 0.2, 0.4, 0.6, 0.8, 1.0, 1.2, 1.5, 2.0, 2.5, 3.0
HHbO	Valoare setată CH pentru centrală (***)	1	°C	85°C	30 ÷ 85°C
EXIT	Exit				

(*) cererea se activează dacă $T_{amb} < T_{set} - HO_n$

(**) cererea se oprește dacă $T_{amb} > T_{set} + HO_F$

(***) numai cu conexiune OpenTherm

7) Exit

» Apăsați „set” ← pentru a reveni la meniul principal.

5.8 Compensarea cu temperatura externă.

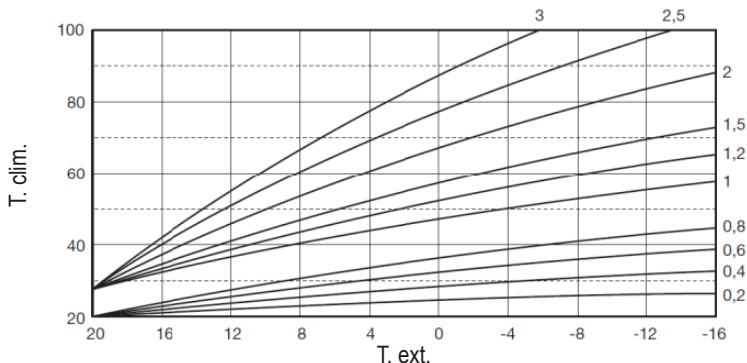

Datorită temperaturii externe (de la WEB sau conectată la centrală), termostatul calculează temperatura din turul centralei, optimizând consumurile. Acționând asupra parametruului CLI (vezi meniul instalatorului PL), se reglează contribuția după formula:

$$T_{tur} = T_{clim} + 10 \times CLI \times (T3 - T4)$$

Pentru a dezactiva sonda externă, setați CLI = 0, în acest caz veți avea:

$$T_{tur} = LLCH + 10 \times (T3 - T4)$$

T3 = setare încăpere





















T4 = temperatură ambiantă

T clim = vezi graficul

LLCH = vezi meniul instalatorului PL

5.9 Receptor

Unitatea de recepție permite schimbul de date între termostat și centrală. Există un buton cu leduri colorate, care indică starea sistemului.

LED Verde	LED Rosu	DESCRIERE				
Intermitent lent	Intermitent lent					
ON	Intermitent lent					
ON	OFF					
Intermitent rapid	OFF				Conexiune WiFi în curs	
OFF	Intermitent rapid				Conexiune RF în curs	

6. SPECIFICAȚII TEHNICE

Electrice/ mecanice	Alimentare	100 ~ 240 Vac, 50 / 60 Hz
	Consumuri	1,2 W
	leșire rele	Contact curat - 0,25 A - 230 V c.a., 2 A - 30 V c.c.
	Termostat	90 x 90 x 22 mm
	Receptor	86 x 86 x 21 mm
	Culoare	Negru + argintiu
	Materialul învelișului	ABS + aluminiu
Wi-Fi	Senzor de temperatură	încorporat
	Standard Wi-Fi	802.11 b/g/n
	Frecvență Wi-Fi	2.412 GHz – 2.484 GHz
	Frecvență RF	868 MHz [FSK]
	Distanță RF	maxim 40 m în loc liber (*)
	Antenă	încorporată
	Securitate	WEP / WPA - PSK / WPA2 - PSK
Protocol	IPv4, TCP	
Tip de rețea	STA	

() Eventualele obstacole sau ziduri pot reduce raza de acțiune a semnalului WiFi. În acest caz, apropiați gateway-ul de router sau folosiți un amplificator WiFi.*

1.	Предисловие	144
2.	Общие правила техники безопасности	144
3.	Класс управления по регламенту EтP	144
4.	Инструкции для установщика	145
4.1	Содержание	145
4.2	Установка приемника	146
4.3	Установка термостата	148
4.4	Монтаж опоры термостата	149
5.	Инструкции для конечного пользователя	150
5.1	Кнопки и значки	150
5.2	Функциональная схема	152
5.3	Конфигурация системы	153
5.3.1	Создание учетной записи	153
5.4	Конфигурация PЧ-соединения («приемник - термостат»)	153
5.5	Конфигурация Wi-Fi (приемник-маршрутизатор)	154
5.6	Приложение СОИИЕСТ	155
5.6.1	Ручной режим	158
5.6.2	Режим «Еженедельное программирование»	159
5.6.3	Режим "Отпуск"	163
5.6.4	Режим "Термостат выключен"	163
5.7	Термостат	164
5.7.1	Основные операции	164
5.8	Компенсация за счет внешней температуры	168
5.9	Приемник	169
6.	Технические характеристики	170

1. ПРЕДИСЛОВИЕ

Уважаемый покупатель, спасибо за выбор «умного» термостата СОИИЕСТ.

С его помощью вы сможете с точностью отслеживать температуру в помещении и, благодаря технологии Wi-Fi, управлять им дистанционно с помощью специального программного приложения.

Данное руководство предназначено для установщиков и конечных пользователей.

Основным элементом системы является хронотермостат, который способен управлять программами, задаваемыми через приложение, измерять местную температуру и посылать сигналы включения/выключения на блок дистанционного управления, подключенный непосредственно к котлу.

2. ОБЩИЕ ПРАВИЛА ТЕХНИКИ БЕЗОПАСНОСТИ

- Внимательно прочитайте инструкции, приведенные в этом руководстве.
- После установки проинформируйте пользователя о функциональных возможностях устройства и оставьте ему это руководство для бережного хранения в качестве неотъемлемой части изделия и обращения за справкой в будущем.
- Монтаж и техническое обслуживание должны выполняться опытным и квалифицированным персоналом в соответствии с действующими правилами и инструкциями производителя. Не выполняйте никаких операций на печатанных элементах управления.
- Отключайте источник питания перед проведением чистки.
- Не размещайте устройство рядом с источниками тепла.
- Храните устройство в недоступном для детей месте.

3. КЛАСС УПРАВЛЕНИЯ ПО РЕГЛАМЕНТУ ERP

В соответствии с Делегированным регламентом Евросоюза (ЕС) №811/2013 данные, представленные в таблице, могут использоваться для маркировки отопительной техники. Возможные комбинации с СОИИЕСТ, соответствующие классы конфигурации и энергетическая доля в системе.

Тип котла	СОИИЕСТ	Класс и доля
Котел с постоянной температурой подачи (On-Off)	Типа On-Off	I = 1%
Котел с переменной температурой подачи (уставка и коммуникационная шина)	Подключение через коммуникационную шину. Заданное значение подачи рассчитывается на основе комнатной и наружной температуры.	VI = 4%
	Подключение через коммуникационную шину. Уставка подачи, рассчитываемая на основе как минимум 3 различных температур окружающей среды (требуется по крайней мере 3 термостата и 3 зонных клапана)	VIII = 5%

4. ИНСТРУКЦИИ ДЛЯ УСТАНОВЩИКА

4.1 Содержание

В состав коробки входят следующие части:



Передачик
Хронотермостат



Приемник



Руководство по
эксплуатации



USB-кабель



Блок питания

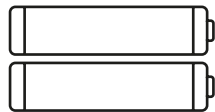

Аккумуляторные батареи
типа AAA



Настольная опора

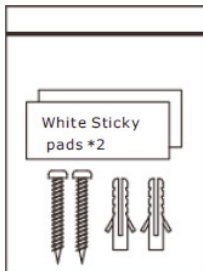

Принадлежности

4.2 Установка приемника

ВНИМАНИЕ: перед подключением устройства отключите электропитание от котла в качестве защитной меры. Операция должна осуществляться опытным персоналом.

Приемник может работать с протоколом OpenTherm или через контакт On-Off ("Вкл./Выкл.").

Используйте магнитную пластинку или двустороннюю клейкую ленту из состава дополнительных принадлежностей, чтобы расположить приемник в наилучшем положении

с учетом качества поверхности, или используйте винты для крепления непосредственно к стене.

Межсетевой интерфейс должен устанавливаться внутри здания и не должен закрываться каким-либо металлическим корпусом.

Функция OpenTherm (А рис. 1): Подключите два красных провода с этикеткой **OTBus**, идущие от приемника, к месту на котле, где предусмотрено подключение **OpenTherm**. Оставьте два других провода отключенными. в этом случае доступна дополнительная информация о состоянии котла «5.7.1 Основные операции» на стр. 164.

Функция On-Off (В рис. 1): Подключите два черных провода с этикеткой **ON/OFF**, идущие от приемника, к месту на котле, где предусмотрено подключение к термостату **ON/OFF**. Оставьте два других провода отключенными.



рис. 1

После включения электропитания на мгновение зажгутся светодиоды.

4.3 Установка термостата

Отделите СОИИЕСТ от основания рис. 2.

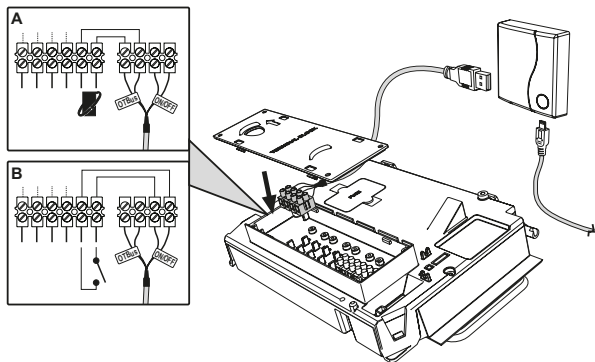
Закрепите основание с помощью прилагаемых винтов рис. 3.

В случае прямого подключения термостата к котлу или к зональному клапану необходимо подключить кабели к соответствующей клемме рис. 4.

Вставьте 2 батарейки AAA по 1,5 в рис. 5.

Закрепите СОИИЕСТ на основании рис. 6.



рис. 2



рис. 3

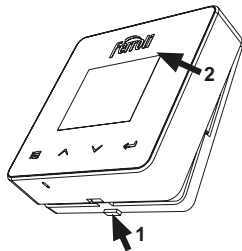

рис. 4

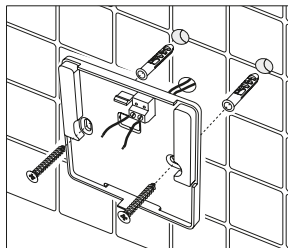

рис. 5

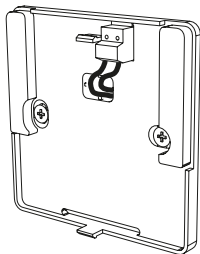

рис. 6

4.4 Монтаж опоры термостата

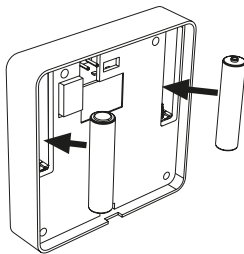

рис. 7 - Опора термостата

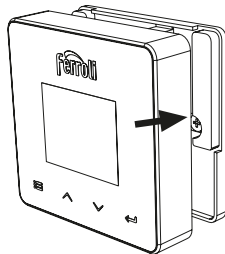
5. ИНСТРУКЦИИ ДЛЯ КОНЕЧНОГО ПОЛЬЗОВАТЕЛЯ

5.1 Кнопки и значки

Ниже приведено описание символов на дисплее и значения кнопок.

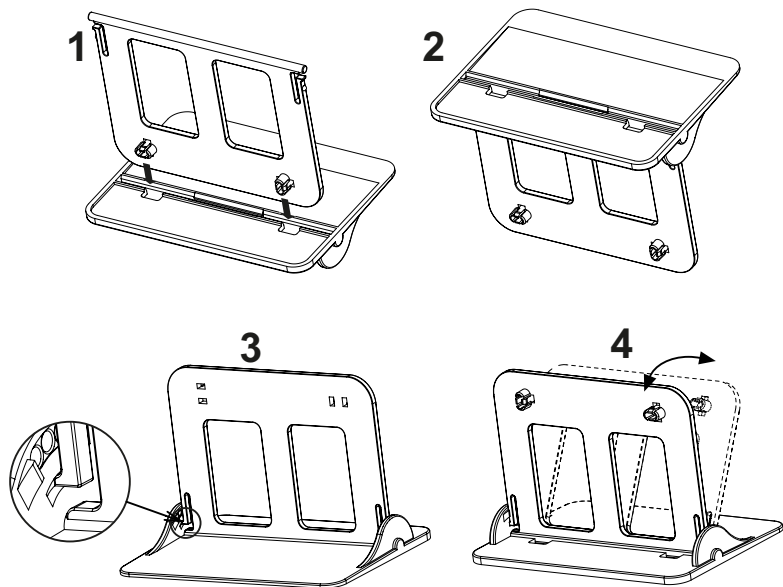

рис. 8

Значок	Описание
	Режим отопления
	Режим ГВС
	Запрос на подачу тепла
	ВЫКЛ.
	АВТОМАТИЧЕСКИЙ режим
	РУЧНОЙ режим
	Режим ОТПУСК

Значок	Описание
	РЧ-соединение
	Wi-Fi-соединение
	Низкий заряд батареи
	Температура и время
	Режим/сохранить/выйти
	Выше
	Ниже
	set
	Кнопка СИД

Батарея: При недостаточном уровне заряда батареи на экране загорается соответствующий значок.

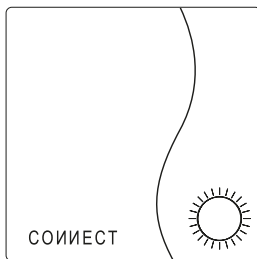
Пламя

- » Термостат подключен к котлу типа On-Off: значок показывает состояние запроса.
- » Термостат подключен к котлу типа OpenTherm: значок показывает состояние горелки.

Примечания: при первом включении термостата он автоматически настраивается на кабельное подключение типа **On-Off**.

Когда термостат и приемник Wi-Fi подключены к беспроводной сети, термостат автоматически переключается в **радиочастотный режим On-Off**.

Когда приемник Wi-Fi подключен к котлу через OpenTherm, термостат автоматически переключается в **радиочастотный режим OpenTherm**.

Если термостат был настроен на радиочастотное подключение (On-Off или OpenTherm), он не переключается автоматически в **кабельный режим On-Off**. Это можно сделать только путем вынимания и обратной установки на место батарей.

ГВС: значок указывает на то, что режим ГВС активен.

Примечание: значок присутствует только в случае радиочастотного соединения с котлами OpenTherm.

Отопление: значок указывает на включенный режим отопления.

Примечание: значок присутствует только в случае радиочастотного соединения с котлами OpenTherm.

Температура: отображается температура воздуха в помещении или ошибки:

E82: ошибка радиочастотного соединения

E83: ошибка связи OpenTherm

5.2 Функциональная схема



рис. 9

5.3 Конфигурация системы

Для правильной работы приложения с вашим устройством (планшетом или смартфоном) необходимо выполнить следующие действия:

- Загрузите приложение (СОИИЕСТ) прямо из App Store вашего устройства или с помощью QR-кода, расположенного на внешней стороне упаковки.
- После установки перейдите к созданию учетной записи.

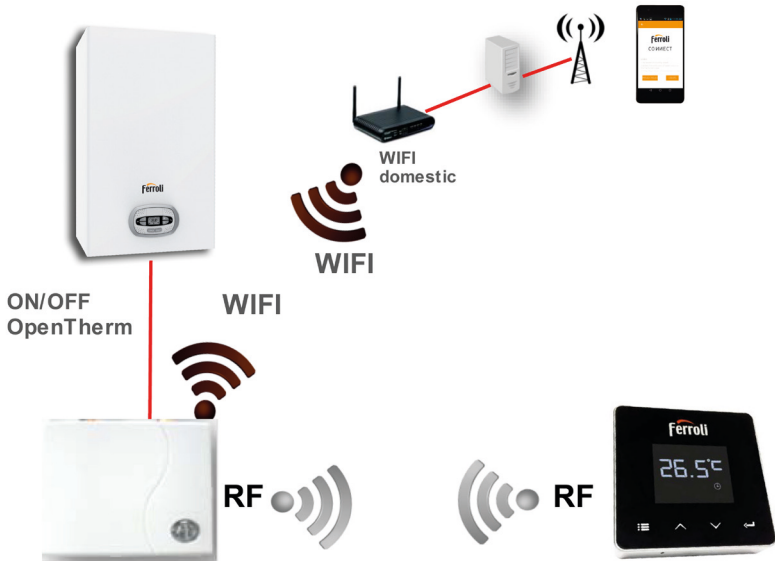



5.3.1 Создание учетной записи

- Убедитесь, что ваш СМАРТФОН/ПЛАНШЕТ подключен к сети Wi-Fi.
- Откройте специальное приложение и нажмите «Зарегистрировать».
- Введите запрашиваемые данные и нажмите на проверку кода.
- Для подтверждения регистрации введите код, полученный по ранее указанной электронной почте.

При управлении котлом несколькими пользователями должна использоваться одна и та же учетная запись.

5.4 Конфигурация РЧ-соединения («приемник - термостат»)

Чтобы установить радиочастотное соединение между термостатом и приемником, выполните следующие действия:

- Нажмите и удерживайте светодиодную кнопку приемника, пока она не начнет мигать (около 7 секунд).
- На термостате удерживайте кнопку **“set”**  нажатой в течение нескольких секунд, пока дисплей не начнет мигать.
- Удерживайте нажатой кнопку , пока не появится **COUP**, а затем нажмите кнопку **“set”** .
- Появление сообщения **«r01, r02...r08»** означает, что соединение установлено. Снова нажмите кнопку **“set”** .

Примечание: обмен данными между термостатом и приемником происходит в течение 2 минут

5.5 Конфигурация Wi-Fi (приемник-маршрутизатор)

Подключите свой смартфон/планшет к локальной сети Wi-Fi.

- Нажмите «+» и введите пароль локальной сети.
- Нажмите «Вперед» ➞.
- На приемнике на мгновение нажмите на кнопку WPS с помощью специального инструмента.
- Нажмите «Вперед» ➞.
- Следуйте инструкциям приложения.

Если процедура не удалась:

- Проверьте Wi-Fi-соединение мобильного устройства (конфигурация должна выполняться с помощью Wi-Fi).
- Проверьте маршрутизатор, перезагрузите мобильное устройство и повторите операции.

5.6 Приложение СОИИЕСТ

Нажмите в указанной точке на главном экране (рис. 10), чтобы получить доступ к управлению одним из настроенных котлов.



рис. 10 - Главное окно

На следующем экране (рис. 11) нажмите **A**, чтобы управлять температурой в помещении, или **B**, чтобы посмотреть состояние котла.



рис. 11 -

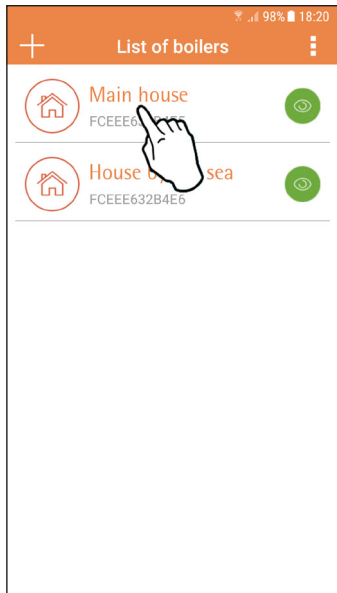

В этом окне можно получить доступ к настройкам подключенного пульта ДУ с таймером.

Если зон несколько, выберите требуемую.

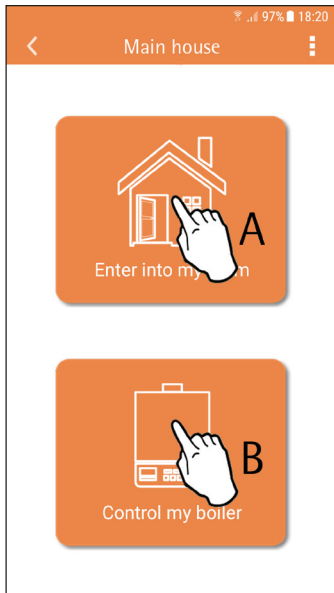



рис. 12 - Управление таймером

Возможные режимы:

 Ручной режим

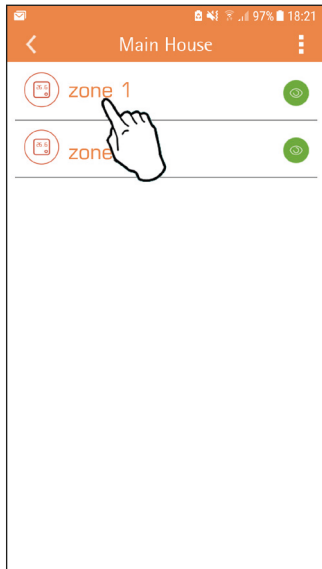
 Режим "Еженедельное программирование"

 Режим «Отпуск»

 Режим "Термостат выключен"



рис. 13 - Возможные режимы



В этом окне (рис. 14), если котел подключен по протоколу OpenTherm, можно посмотреть его состояние. Также, нажатием на символы , можно изменять уставки ГВС и отопления в котле.

Если котел подключен через контакт On-Off, отображается только статус запроса (рис. 15).



рис. 14 - Через OpenTherm



рис. 15 - Через комнатный термостат

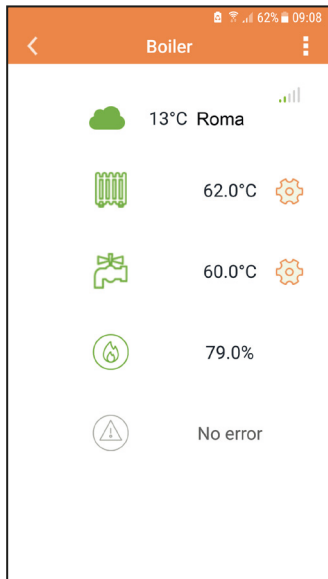

5.6.1 Ручной режим

В этом режиме можно задавать желаемую температуру в помещении.

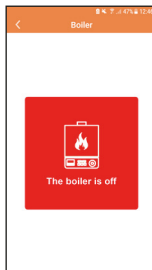
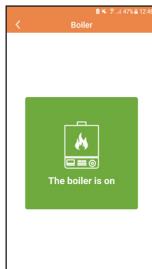

рис. 16

5.6.2 Режим «Еженедельное программирование»

В этом режиме можно устанавливать желаемую температуру в любые часовые интервалы для всех дней недели, нажав в точке “**В**”, указанной на рис. 17.

Кроме того, можно временно изменить желаемую температуру (до следующего временного интервала) не меняя программы, воздействуя на точку “**А**”.

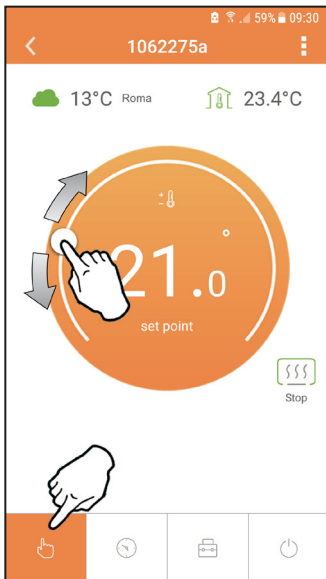

рис. 17

Имеются 3 уровня температуры: T3 (уровень COMFORT 1), T2 (уровень COMFORT 2) и T1 (уровень ECO).

Чтобы задать температуру на уровнях T1, T2 и T3, действуйте в нижеуказанной последовательности.

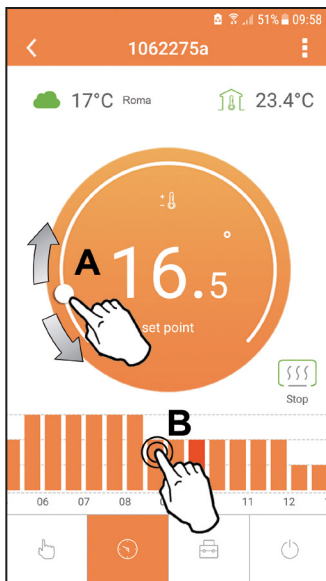

рис. 18



рис. 19

Задайте температуры и подтвердите.

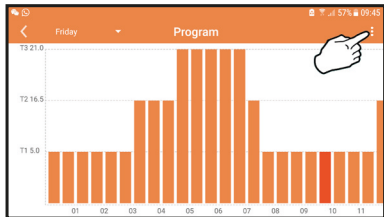

рис. 20 Настройка температур

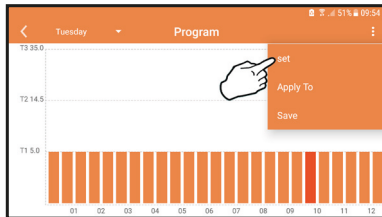
Для редактирования часовых интервалов нажмите на область, куда нужно внести изменения.

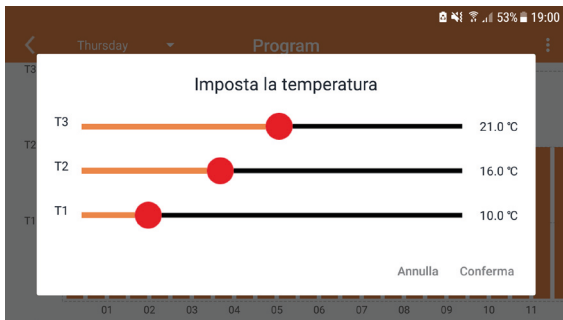

рис. 21

После программирования температур сохраните конфигурацию.

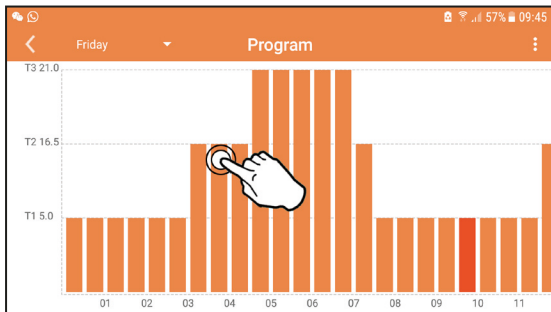

рис. 22

Нажмите «Применить», чтобы выбрать дни для копирования только что выполненных настроек.



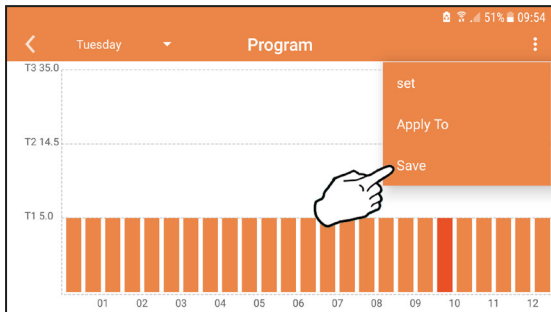

рис. 23

Если доступна информация о температуре наружного воздуха (через WEB или OpenTherm), температура, заданная в котле, учитывает это значение для регулировки расхода.

Если температура наружного воздуха недоступна, расход регулируется в соответствии с заданной температурой в помещении.

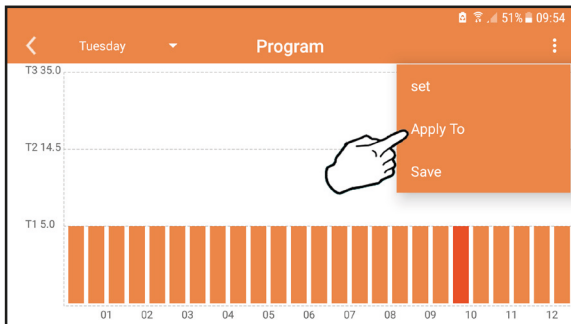
5.6.3 Режим "Отпуск"

В этом режиме котел выключен и будет снова включен, если температура упадет ниже заданной уставки.

Нажав значок настройки , вы можете установить дату окончания отпуска.



рис. 24

5.6.4 Режим "Термостат выключен"

В этом режиме котел выключается и включается только тогда, когда температура опускается ниже 5 °С.



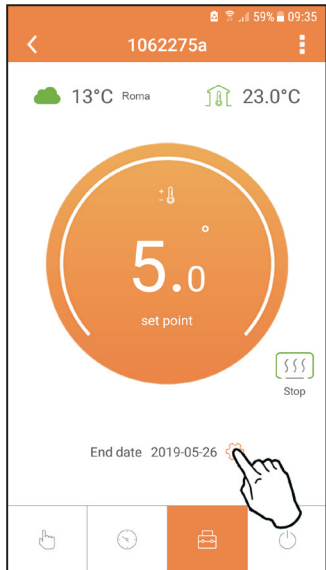







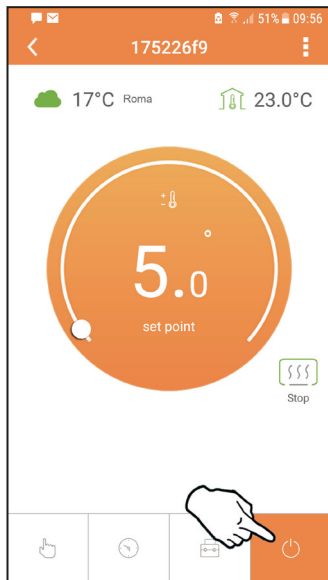





рис. 25

5.7 Термостат







5.7.1 Основные операции

1. Нажатием на кнопку “mode”  осуществляется переключение между различными режимами:
 - a. **Выкл.** : в этом режиме запрос на отопление отключен, и только противоморозная защита остается активной.
 - b. **Отпуск** : заданная температура является энергосберегающей температурой противоморозной защиты в течение количества дней, заданного с помощью кнопок  .
 - c. **Автоматический** : температура соответствует заданной через приложение в недельной программе. Если программа не была задана, то используется системное значение по умолчанию.
 - d. **Ручной** : температура задается вручную непосредственно на термостате.
2. **Настройка температуры:**
 - a. **Ручная:** используйте кнопки  .
3. **Меню настроек:** чтобы войти в меню настроек, нажмите на кнопку “set”  на 2 секунды.
 - a. “ и  для входа в выбранный параметр.
 - c. “mode”  для возврата в главное меню.
4. В случае неисправности котла код ошибки отображается также на дисплее термостата. Сбой можно разблокировать с помощью кнопки “set” .









За описанием неисправности обращайтесь к руководству по эксплуатации котла.

№	Параметр	Дисплей	Описание
1)	Часы	14:05	Для настройки часов, минут, года (y), месяца (m), дня (d).
2)	Температура	23.0°C	Установка температуры CFT1, CFT2, ECO, FRST
3)	Код COUP	COUP	Код РЧ (см. параграф «5.4» на стр. 153)
4)	Уставка ГВС	80°C	Для настройки температуры воды в режиме ГВС: функция доступна только для подключения OpenTherm.
5)	Информация о котле	INFO	Считывание некоторых параметров котла только при подключении OpenTherm.
6)	Данные установщика	PL	Параметры для установщика
7)	Выход	EXIT	Возвращение на начальную страницу

1) Часы

- » Используйте кнопки  и , чтобы выбрать меню часов, а затем нажмите **“set”**  для входа.
- » Нажатием кнопки **“set”**  можно выбрать параметр, который требуется отредактировать, согласно следующей последовательности: 13:00 часы, 13:42 минуты, 19 y год, 02 m месяц, 21 d день.
- » Используйте кнопки  и , чтобы изменить значение.
- » Нажмите **“mode”** , чтобы вернуться назад.







2) Температура

- » Используйте кнопки  и , чтобы выбрать меню температуры, а затем **“set”** , чтобы войти в него.
- » Используйте кнопки  и  для выбора редактируемых температур:
- » **“Комфорт”** (CF E) – **“Экономия”** (EE E) – **“Противоморозная защита”** (Fr E)
- » Используйте кнопки  и , чтобы изменить значение выбранной температуры.
- » Нажмите **“set”**  или **“mode”** , чтобы вернуться в предыдущее меню.

3) Код связи





» См. параграф «5.4» на стр. 153.

4) Температуры ГВС (только для котлов OpenTherm)

- » Используйте кнопки  , чтобы выбрать меню температуры ГВС, а затем “set” , чтобы войти в него.
- » Используйте кнопки  , чтобы изменить значение.
- » Нажмите “set”  или “mode” , чтобы вернуться в предыдущее меню.

Примечание: если термостат получает информацию от котла, он отображает это значение, в противном случае диапазон настройки составляет 30 - 60°C.















5) Информация от котла (только для котлов OpenTherm)

- » Используйте кнопки  , чтобы выбрать меню информации, а затем “set” , чтобы войти в него.
- » Отображение “- - -” означает, что данная конкретная информация в котле недоступна.
- » Нажмите “set”  или “mode” , чтобы вернуться в предыдущее меню.

№	Информация
1	Уставка подачи
2	Датчик в подающем контуре
3	Датчик в обратном контуре
4	Температура воды ГВС
5	Температура в помещении
6	Процент мощности
7	Забор ГВС
8	Давление в системе

6) Расширенные настройки (PL)

» Параметры для установщика

- » Нажмите кнопки   для выбора “PL” меню, а затем «set» , чтобы войти.
- » С помощью клавиш   найдите значение «PS 10» и нажмите «set» . Выберите параметр, который нужно изменить (см. таблицу ниже), с помощью клавиш  , и нажмите “set” . Измените выбранный параметр с помощью клавиш  , а затем нажмите “set” , чтобы подтвердить изменение.
- » Нажмите «set»  или «mode» , чтобы вернуться в предыдущее меню.

Параметр	Описание	Шаг	Ед.изм.	Значение по умолчанию	Диапазон
САЦ	Калибровка датчика температуры окружающей среды	0,1	°C	Температура окружающей среды	-7,0 + 7,0°C
FRct	Сброс на заводские настройки		---	НЕТ	НЕТ-ДА
HO _n	Гистерезис ВКЛ. (*)	0,1	°C	0,4	0,0 ÷ 2,0
HO _F	Гистерезис ВЫКЛ. (**)	0,1	°C	0,1	0,0 ÷ 2,0
btLt	Продолжительность подсветки дисплея			08	03 ÷ 15
HNCH	Макс. уставка подачи (***)	1	°C	85	45 ÷ 85°C
LLCH	Мин. уставка подачи (***)	1	°C	30	10 - HNCH
CLi	Климатическая кривая (***)		---	1,2	0,0, 0,2, 0,4, 0,6, 0,8, 1,0, 1,2, 1,5, 2,0, 2,5, 3,0
HNBO	Уставка котла ЦО (***)	1	°C	85°C	30 ÷ 85°C
ENI E	Выход				

(*) запрос активируется, если $T_{amb} < T_{set} - HO_n$

(**) запрос деактивируется, если $T_{amb} > T_{set} + HO_F$

(***) только с подключением OpenTherm

7) Выход

» Нажмите “set” ←, чтобы вернуться в главное меню.

5.8 Компенсация за счет внешней температуры.

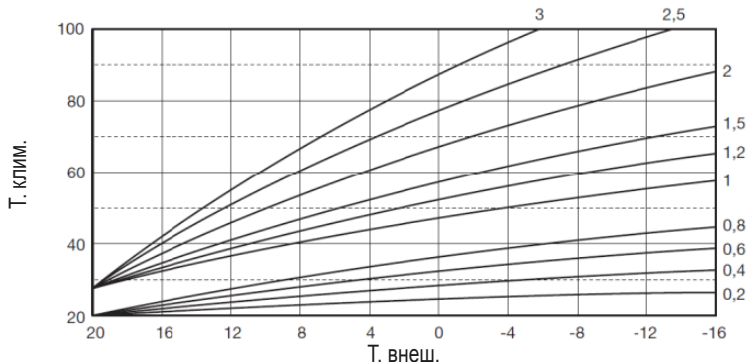

Благодаря наружной температуре (через WEB или подключение к котлу) термостат рассчитывает температуру подачи котла, оптимизируя потребление. Используя параметр CLI (см. меню установщика PL), можно отрегулировать ее вклад по формуле:

$$T_{\text{поддачи}} = T_{\text{клим.}} + 10 \times \text{CLI} \times (T_3 - T_4)$$

Чтобы отключить внешний датчик, задайте CLI = 0; в этом случае мы получим:

$$T_{\text{поддачи}} = \text{LLCH} + 10 \times (T_3 - T_4)$$

T₃ = уставка окр. среды





T₄ = темп. окр. среды

T клим. = см. график

LLCH = см. меню установщика PL

5.9 Приемник

Приемник позволяет осуществлять обмен данными между термостатом и котлом. Он имеет кнопку с цветными светодиодами для индикации состояния системы.

Зеленый светодиод	Красный светодиод	ОПИСАНИЕ				
Медленный мигание	Медленный мигание					
Вкл	Медленный мигание					
Вкл	Выкл					
Быстрое мигание	Выкл				Выполняется подключение к Wi-Fi	
Выкл	Быстрое мигание				Выполняется подключение радиочастотного	

6. ТЕХНИЧЕСКИЕ ХАРАКТЕРИСТИКИ

Электрические/ механические	Питание	100 ~ 240 в пер. тока, 50/60 Гц
	Потребление	1,2 Вт
	Выход реле	Чистый контакт - 0,25А - 230 В пер. тока, 2А - 30 В пост. тока
	Термостат	90 x 90 x 22 мм
	Приемник	86 x 86 x 21 мм
	Цвет	Черный + серебристый
	Материал упаковки	ABS + алюминий
	Датчик температуры	Встроенный
Wi-Fi	Стандарт Wi-Fi	802,11 b/g/n
	Частота Wi-Fi	2,412 ГГц – 2,484 ГГц
	Частота РЧ-сигнала	868 МГц [FSK]
	Охват РЧ-сигнала	макс 40 м в свободном поле (*)
	Антенна	Встроенная
	Безопасность	WEP/WPA - PSK/WPA2 - PSK
	Протокол	IPv4, TCP
Тип сети	STA	

() Любые препятствия или стены могут снизить дальность сигнала Wi-Fi. В этом случае сократите расстояние между межсетевым интерфейсом и маршрутизатором или используйте ретранслятор Wi-Fi.*

1.	Prezentacja	172
2.	Ogólne zasady bezpieczeństwa	172
3.	Klasa sterowania wg rozporządzenia ErP	172
4.	Dla instalatora	173
4.1	Zawartość	173
4.2	Wymiana odbiornika	174
4.3	Instalacja termostatu.....	176
4.4	Montaż wspornika termostatu.....	177
5.	Dla użytkownika końcowego	178
5.1	Przyciski i ikony	178
5.2	Schemat funkcjonalny	180
5.3	Konfiguracja systemu	181
5.3.1	Tworzenie konta	181
5.4	Konfiguracja RF (Odbiornik - Termostat).....	181
5.5	Konfiguracja Wi-Fi (Odbiornik - Router).....	182
5.6	Aplikacja СОИИЕСТ.....	183
5.6.1	Tryb ręczny.....	186
5.6.2	Tryb „Programowanie tygodniowe”	187
5.6.3	Tryb wakacje	191
5.6.4	Tryb Termostat wyłączony.....	191
5.7	Termostat	192
5.7.1	Czynności podstawowe.....	192
5.8	Kompensacja przy użyciu temperatury zewnętrznej.	196
5.9	Odbiornik	197
6.	Specyfikacje techniczne.....	198

1. PREZENTACJA

Szanowny Kliencie! Dziękujemy za wybranie termostatu smart COMECT.

Dzięki niemu możliwe będzie precyzyjne kontrolowanie temperatury otoczenia, zaś podłączenie do sieci Wi-Fi pozwoli na sterowanie zdalne za pomocą dedykowanej aplikacji.

Niniejsza instrukcja jest przeznaczona dla instalatorów oraz użytkowników końcowych.

Podstawowym elementem systemu jest termostat pokojowy, który pozwala na zarządzanie programami godzinowymi ustawionymi w aplikacji, mierzenie temperatury w danej strefie oraz przesyłanie polecenia włączenia/wyłączenia do zdalnej centrali podłączonej bezpośrednio do kotła.

2. OGÓLNE ZASADY BEZPIECZEŃSTWA

- Przeczytać uważnie wszystkie informacje zawarte w niniejszej instrukcji.
- Po zainstalowaniu poinformować użytkownika o funkcjach urządzenia oraz pozostawić mu niniejszą instrukcję. Stanowi ona integralną część urządzenia i należy ją starannie przechowywać, aby można było z niej skorzystać w przyszłości.
- Przeprowadzanie instalacji oraz konserwacji należy zlecać wykwalifikowanemu personelowi. Powinny one być wykonywane zgodnie z obowiązującymi przepisami oraz zgodnie z instrukcjami producenta. Nie wykonywać żadnych czynności przy częściach zabezpieczonych plombami.
- Przed rozpoczęciem czyszczenia odłączyć zasilanie elektryczne.
- Nie ustawiać urządzenia w pobliżu źródeł ciepła.
- Chronić przed dziećmi.

3. KLASA STEROWANIA WG ROZPORZĄDZENIA ERP

Zgodnie z rozporządzeniem delegowanym (UE) nr 811/2013 dane przedstawione w tabeli mogą być wykorzystane w etykiecie ogrzewaczy pomieszczeń.

Możliwe nowe połączenia z COMECT, odnośne klasy konfiguracji oraz pobór energii energetyczny w systemie.

Typ kotła	CONNECT	Klasa i pobór
Kocioł o stałej temperaturze przesyłu (Wł.-Wył.)	Typ Wł./Wył.	I = 1%
Kocioł o zmiennej temperaturze przesyłu (nastawa za pomocą magistrali komunikacyjnej)	Połączenie przez magistralę komunikacyjną. Nastawa przesyłu obliczona na podstawie temperatury otoczenia i temperatury zewnętrznej.	VI = 4%
	Połączenie przez magistralę komunikacyjną. Nastawa przesyłu obliczona na podstawie co najmniej 3 różnych temperatur otoczenia (żądania co najmniej 3 termostatów oraz 3 zaworów strefowych)	VIII = 5%

4. DLA INSTALATORA

4.1 Zawartość

Skrzynka zawiera następujące części:



Nadajnik
termostat pokojowy



Odbiornik



Instrukcja



Przewód USB



Zasilacz

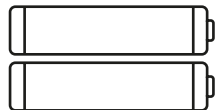

Baterie AAA



Wspornik stołowy

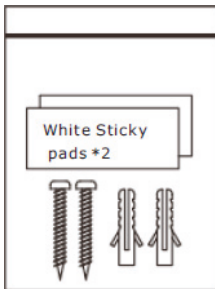

Akcesoria

4.2 Wymiana odbiornika

UWAGA: Odłączyć kocioł od zasilania przed przystąpieniem do wykonania podłączenia, aby zabezpieczyć urządzenie. Czynność powinna być wykonywana przez wykwalifikowany personel.

Odbiornik może pracować z protokołem OpenTherm lub ze stykiem Wł.-Wył.

Za pomocą magnetycznej płytki lub dwustronnej taśmy klejącej dostarczonych w komplecie z akcesoriami - w zależności od rodzaju powierzchni - ustawić odbiornik w odpowied-

niej pozycji. Aby przymocować odbiornik na stałe w ścianie, użyć śrub.
Bramka powinna być zainstalowana wewnątrz budynku i nie powinna być osłonięta żadnymi ewentualnymi osłonami metalowymi.

Opcja OpenTherm (A rys. 1): Podłączyć dwa czerwone przewody z etykietą **OTBus**, wychodzące z odbiornika, do kotła, w miejscu, w którym przewidziano połączenie **OpenTherm**. Pozostawić pozostałe dwa przewody odłączone. W takim przypadku ma się do dyspozycji więcej informacji na temat stanu kotła (patrz „5.7.1 Czynności podstawowe” a pag. 192).

Opcja On-Off (B rys. 1): Podłączyć dwa czarne przewody z etykietą **ON/OFF**, wychodzące z odbiornika, do kotła, w miejscu, w którym przewidziano połączenie z termostatem **ON/OFF**. Pozostawić pozostałe dwa przewody odłączone.

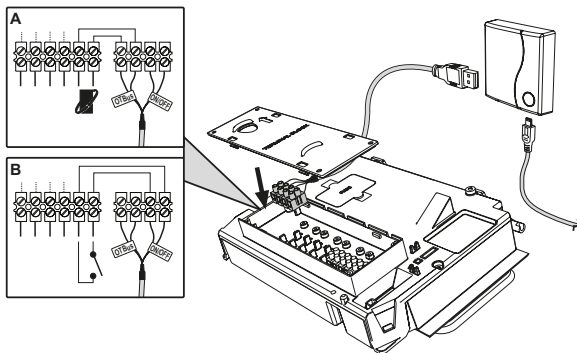

rys. 1

Po podłączeniu zasilania przez chwilę migają diody led.

4.3 Instalacja termostatu

Oddzielić CONNECT od podstawy rys. 2.

Zamocować podstawę za pomocą śrub dołączonych w komplecie rys. 3.

Jeśli termostat jest podłączony bezpośrednio do kotła lub do zaworu strefowego, konieczne jest podłączenie przewodów do odpowiedniego zacisku rys. 4.

Włóż 2 baterie 1,5 V typu AAA rys. 5.

Zamocować CONNECT na podstawie rys. 6.

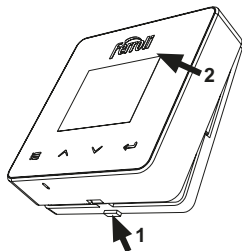

rys. 2

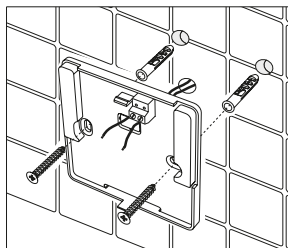

rys. 3

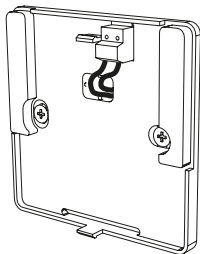

rys. 4

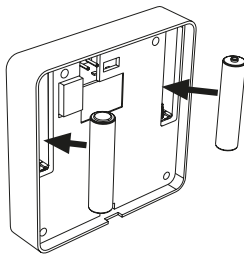

rys. 5

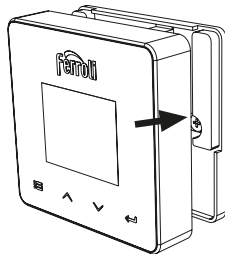

rys. 6

4.4 Montaż wspornika termostatu

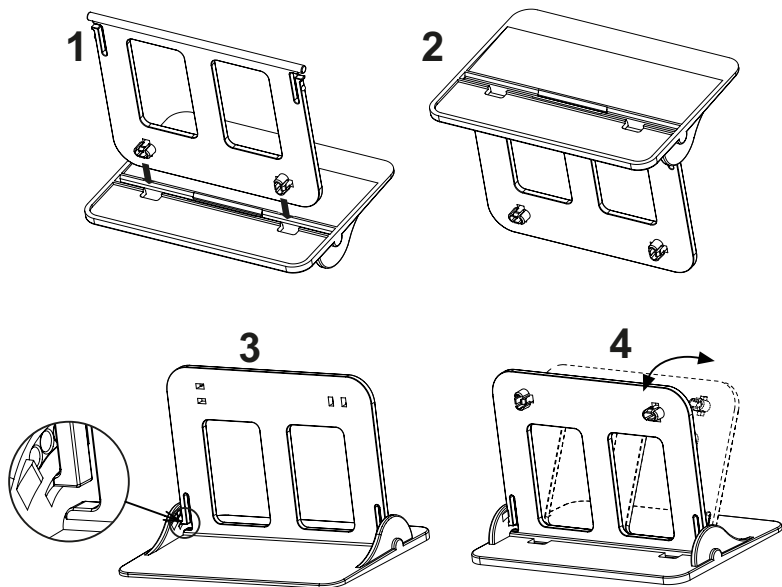

rys. 7 - Wspornik termostatu

5. DLA UŻYTKOWNIKA KOŃCOWEGO

5.1 Przyciski i ikony

Poniżej podano opis symboli na wyświetlaczu oraz znaczenie przycisków.

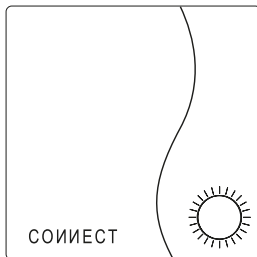

rys. 8

Ikona	Opis
	Ogrzewanie
	Ciepła woda użytkowa
	Zapotrzebowanie na ciepło
	OFF
	Tryb AUTO
	Tryb RĘCZNY
	Tryb WAKACJE

Ikona	Opis
	Połączenie RF
	Połączenie Wi-Fi
	Niski poziom baterii
	Temperatura i godziny
	tryb/zapisz/wyjdz
	zwiększenie
	zmniejszenie
	set
	Przycisk LED

Bateria: Kiedy poziom baterii jest niewystarczający, na ekranie włącza się odpowiednia ikona.

Płomień

- » W przypadku termostatu podłączonego do kotła on-off ta ikona informuje o stanie żądania.
- » W przypadku termostatu podłączonego do kotła OpenTherm ta ikona informuje o stanie palnika.

Uwagi: W momencie pierwszego włączenia termostat automatycznie się konfiguruje w trybie podłączenia do przewodu **On-Off**.

Kiedy termostat oraz odbiornik Wifi są podłączone do sieci wireless, termostat automatycznie przełącza się do trybu **RF On-Off**.

Kiedy odbiornik Wifi jest podłączony do kotła OpenTherm, termostat automatycznie przełącza się do trybu **RF OpenTherm**.

Jeśli termostat jest skonfigurowany jako RF (on-off lub OpenTherm), nie przełącza się automatycznie do trybu **przewód On-Off**. Może to zostać wykonane tylko poprzez wyjęcie i ponowne włożenie baterii.

Ciepła woda użytkowa: ikona ta informuje, że ciepła woda użytkowa jest włączona.

Uwagi: Ikona ta pojawia się wyłącznie wtedy, kiedy obecne jest połączenie RF z kotłami OpenTherm.

Ogrzewanie: Ikona ta informuje, że włączone jest ogrzewanie.

Uwagi: Ikona ta pojawia się wyłącznie wtedy, kiedy obecne jest połączenie RF z kotłami OpenTherm.

Temperatura: Wyświetla się temperatura otoczenia lub błąd:

E82: Błąd komunikacji RF

E83: Błąd komunikacji OpenTherm

5.2 Schemat funkcjonalny



rys. 9

5.3 Konfiguracja systemu

Aby umożliwić prawidłowe działanie z odpowiednim urządzeniem (tablet lub smartfon), konieczne jest wykonanie następujących kroków:





- Pobrać aplikację (CONNECT) bezpośrednio z App Store na urządzeniu lub za pomocą QR CODE znajdującego się na opakowaniu.
- Po zainstalowaniu utworzyć konto.

5.3.1 Tworzenie konta

- Upewnić się, że urządzenie SMARTFON/TABLET jest podłączone do sieci Wifi.
 - Otworzyć dedykowaną aplikację i kliknąć „Zarejestruj”.
 - Wpisać żądane dane i nacisnąć sprawdzenie kodu.
 - Aby potwierdzić rejestrację, wpisać kod otrzymany na podany wcześniej adres e-mail.
- Aby zarządzać kotłem z kilku urządzeń, wpisać to samo konto.

5.4 Konfiguracja RF (Odbiornik - Termostat)

Aby utworzyć połączenie RF między termostatem a odbiornikiem, wykonać następujące kroki:

- Naciskać przycisk led na odbiorniku do momentu, aż nie zacznie migać (około 7 sekund).
- Na termostacie nacisnąć przycisk „set”  i przytrzymać przez kilka sekund, aż do momentu, kiedy wyświetlacz nie zacznie migać.
- Naciskać przycisk  do momentu, kiedy pojawi się **LOUP**, a następnie nacisnąć przycisk „set” .
- Po pojawieniu się komunikatu „r01, r02...÷...r08” połączenie jest nawiązane. Ponownie nacisnąć przycisk „set” .

Uwaga: Wymiana danych pomiędzy termostatem a odbiornikiem trwa do 2 minut

5.5 Konfiguracja Wi-Fi (Odbiornik - Router)

Podłączyć urządzenie Smartfon/Tablet do lokalnej sieci Wifi.

- Kliknąć „+” i wpisać hasło sieci lokalnej
- Nacisnąć „dalej” ➞.
- Na odbiorniku wcisnąć na chwilę przycisk WPS za pomocą specjalnego narzędzia
- Nacisnąć „dalej” ➞.
- Wykonać instrukcje z aplikacji

Jeśli procedura się nie powiodła:

- Sprawdzić połączenie Wifi w urządzeniu mobilnym (konfiguracja powinna być wykonana za pośrednictwem Wifi)
- Sprawdzić router, zrestartować urządzenie mobilne i powtórzyć czynności

5.6 Aplikacja CONNECT

Na stronie głównej (rys. 10) nacisnąć we wskazanym miejscu, aby przejść do sterowania jednym ze skonfigurowanych kotłów.

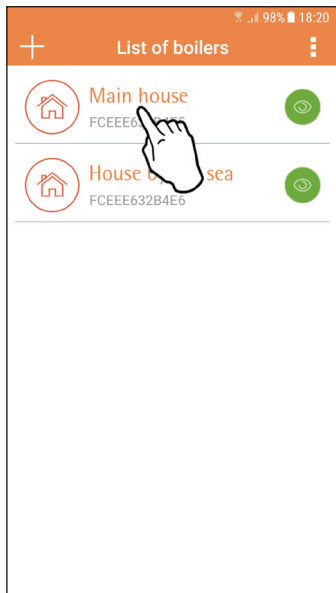

rys. 10 - Ekran główny

Na następnej stronie (rys. 11) nacisnąć **A**, aby zarządzać regulacją temperatury otoczenia lub nacisnąć **B**, aby wyświetlić stan kotła.

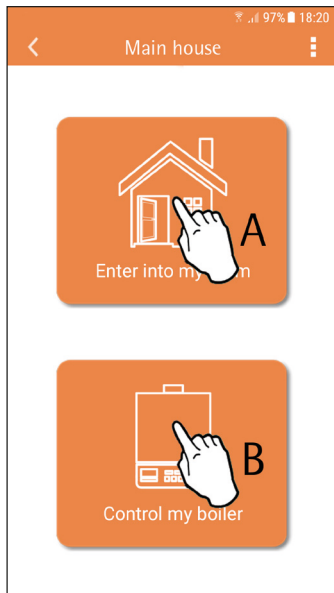

rys. 11 -



Na tym ekranie można wpisać nastawę podłączonego zdalnego panelu pokojowego.

Jeśli dostępnych jest kilka stref, wybrać żądaną.

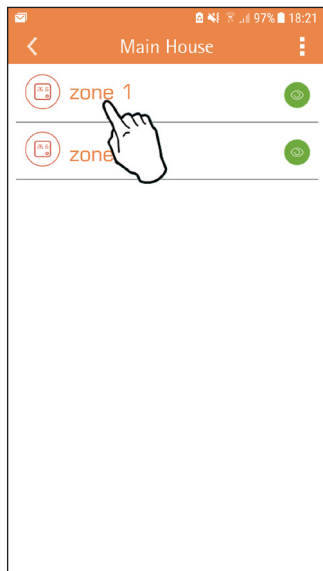

rys. 12 - Sterowanie z panelu pokojowego

Możliwe tryby:

 Tryb ręczny

 Programowanie tygodniowe

 Tryb wakacje

 Termostat wyłączony



rys. 13 - Możliwe tryby



Na tej stronie (rys. 14), jeśli kocioł jest połączony za pomocą protokołu Open-Therm, można wyświetlić jego stan. Można również, klikając na symbole , zmienić nastawę c.w.u. i ogrzewania w kotle.

Jeśli kocioł jest połączony za pomocą styku On-Off, wyświetlany jest tylko stan żądania (rys. 15).

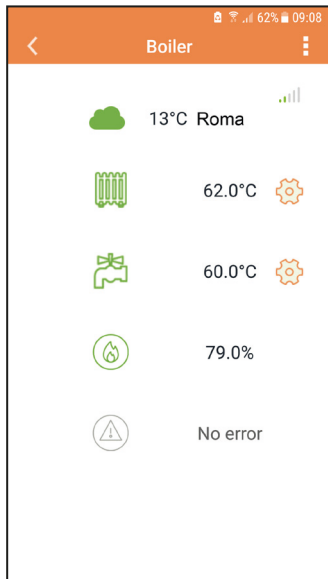

rys. 14 - Z OpenTherm

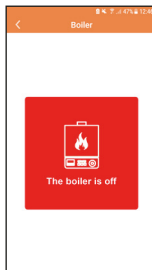
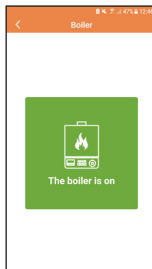

rys. 15 Z termostatem pokojowym



5.6.1 Tryb ręczny

W tym trybie można ustawić żądaną temperaturę otoczenia.

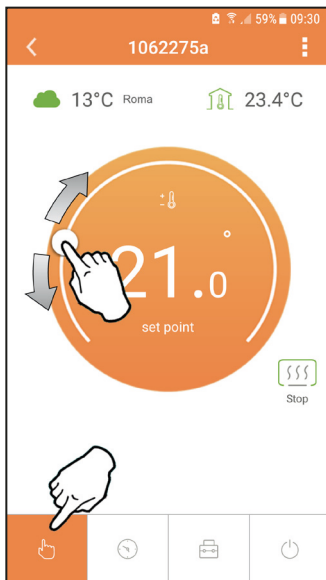

rys. 16

5.6.2 Tryb „Programowanie tygodniowe”

W tym trybie można ustawić żądaną temperaturę w różnych przedziałach godzinowych dla wszystkich dni tygodnia, naciskając w miejscu **“B”** wskazanym na rys. 17.

Można również tymczasowo zmienić temperaturę zadaną (do następnego przedziału godzinowego), naciskając na punkt **“A”**, nie zmieniając przy tym programu.

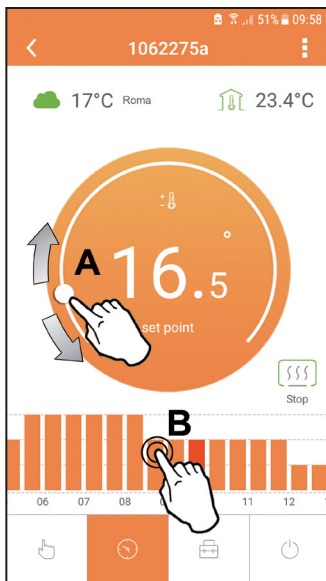

rys. 17

Do dyspozycji są 3 poziomy temperatury: **T3** (Poziom COMFORT 1), **T2** (Poziom COMFORT 2) i **T1** (Poziom ECO).

Aby ustawić temperaturę dla poziomów **T1**, **T2** i **T3**, należy przeprowadzić przedstawioną poniżej sekwencję czynności.

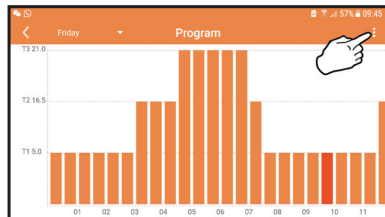

rys. 18

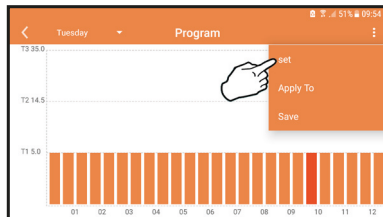

rys. 19

Ustawić temperatury i potwierdzić.

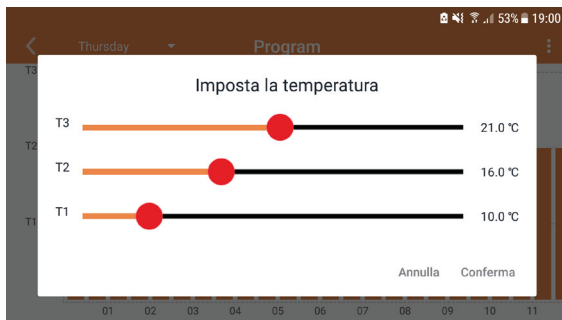

rys. 20 Ustawienie temperatur

Aby zmienić przedziały godzinowe, nacisnąć obszar, który chce się zedytować.

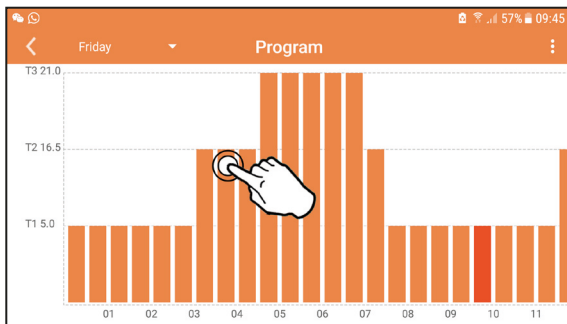

rys. 21

Po zaprogramowaniu temperatur zapisać konfigurację.

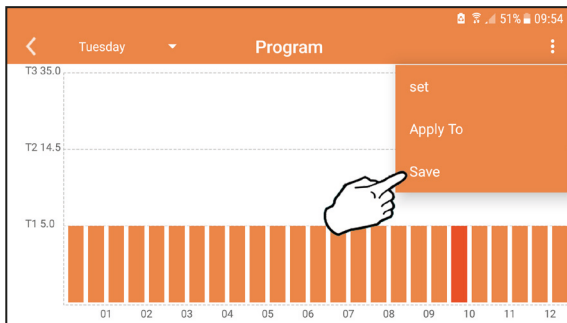

rys. 22

Kliknąć „zastosuj”, aby wybrać dni, do których właśnie wprowadzone ustawienie ma zostać skopiowane.

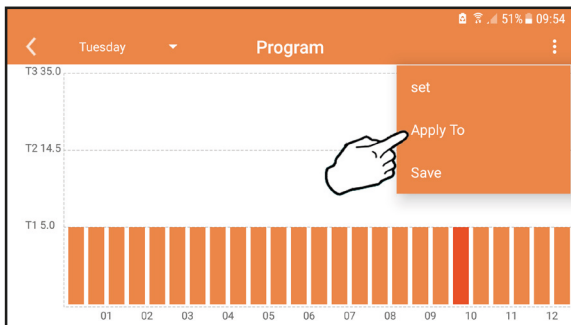

rys. 23

Jeśli dostępna jest informacja o temperaturze zewnętrznej (przez Internet lub Open-Therm), temperatura ustawiona w kotle uwzględnia tę wartość podczas przesyłu.

Jeśli temperatura zewnętrzna nie jest dostępna, przesył jest regulowany na podstawie ustawionej temperatury otoczenia.

5.6.3 Tryb wakacje

W tym trybie kocioł jest wyłączony i zostanie ponownie uruchomiony, jeżeli temperatura spadnie poniżej wskazanej wartości zadanej.

Po naciśnięciu ikony ustawiania  można ustawić datę zakończenia wakacji.

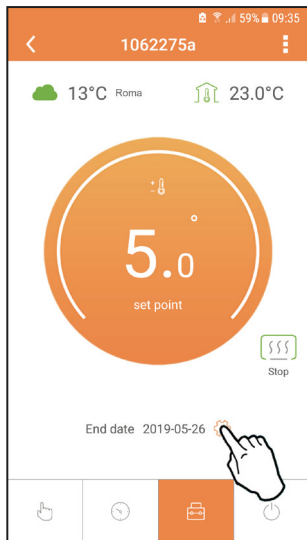

rys. 24

5.6.4 Tryb Termostat wyłączony



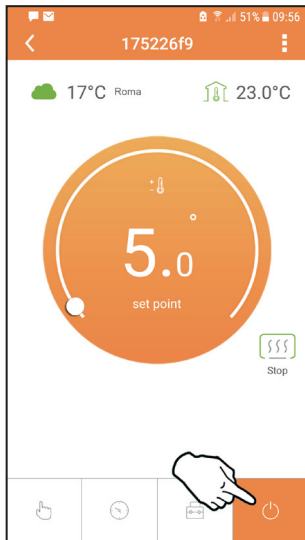











W tym trybie kocioł jest wyłączony i zostanie włączony tylko w sytuacji, kiedy temperatura spadnie poniżej 5°C.



rys. 25

5.7 Termostat







5.7.1 Czynności podstawowe

- Po naciśnięciu przycisku „**mode**”  (tryb) przełącza się pomiędzy różnymi trybami:
 - Off**  (Wył.): w tym trybie żądanie ciepła jest wyłączone, aktywny jest tylko tryb zabezpieczenia przed zamrażaniem.
 - Vacanza**  (Wakacje): ustawiona temperatura to temperatura oszczędzania energii oraz zabezpieczenia przed zamrażaniem obowiązująca przez liczbę dni ustawionych za pomocą przycisków  .
 - Automatic**  (Automatyczny): żądana temperatura to temperatura programu tygodniowego ustawiona za pośrednictwem aplikacji. Jeśli program nie jest ustawiony, używany jest domyślny program systemu.
 - Manuale**  (Ręczny): temperatura jest ustawiana ręcznie bezpośrednio na termostacie.
- Set temperatura** (Ustaw temperaturę):
 - Manuale** (Ręcznie): za pomocą przycisków  .
- Menu impostazioni** (Menu ustawień): po naciśnięciu przycisku „**set**”  i przytrzymaniu przez ok. 2 sekundy następuje wejście do menu ustawień.
 - „” oraz „” pozwalają na przewijanie menu
 - „**set**”  (ustaw) pozwala na wejście do wybranego parametru
 - „**mode**”  (tryb) umożliwia powrót do menu głównego
- W razie nieprawidłowości w działaniu kotła na wyświetlaczu termostatu pojawia się kod błędu. Usterkę można odblokować za pomocą przycisku „**set**” .















Aby zapoznać się z opisem usterki, przeczytać instrukcję kotła.

Nr	Parametr	Wyświetlacz	opis
1)	Zegar	14:05	Ustawia godziny, minuty, rok (y), miesiąc (m), dzień (d).
2)	Temperatura	23.0°C	Ustawienie temperatury CFT1, CFT2, ECO, FRST
3)	Kod COUP	COUP	Kod RF (patrz punkt 5.4 a pagina 181)
4)	Wartość zadana c.w.u.	48.0	Ustawia temperaturę ciepłej wody użytkowej, funkcja dostępna jedynie w połączeniu z OpenTherm
5)	Informacje o kotle	INFO	Odczyt niektórych parametrów kotła jedynie w połączeniu z OpenTherm
6)	Dane instalatora	PL	Parametry dla instalatora
7)	Wyjdz	EXIT	Powrót do strony początkowej

1) Zegar

- » Za pomocą przycisków  oraz  wybrać menu zegar, a następnie wybrać „set” , aby wejść.
- » Za pomocą przycisku „set”  wybrać datę, która ma zostać zmieniona, w następującej kolejności: 13:00 godzina, 13:42 minuty, 19 4 rok, 02 7 miesiąc, 21 d dzień.
- » Za pomocą przycisków  oraz  zmienić wartość.
- » Nacisnąć „mode” , aby powrócić.







2) Temperatura

- » Za pomocą przycisków  oraz  wybrać menu temperatura, a następnie wybrać „set” , aby wejść.
- » Za pomocą przycisków  oraz  wybrać temperatury, które mają być zmienione:
- » **comfort** (CF  ) – **economic** (EC  ) – **antigelo** (FR  ) (zabezpieczenie przed zamrażaniem)
- » Za pomocą przycisków  oraz  zmienić wartość wybranej temperatury.
- » Nacisnąć przycisk „set”  lub “mode” , aby powrócić do poprzedniego menu.





3) Kontrola połączenia

- » Patrz rozdział 5.4 a pagina 181.

4) Temperatury ciepłej wody użytkowej (tylko kotły OpenTherm)

- » Za pomocą przycisków  oraz  wybrać temperaturę ciepłej wody użytkowej, a następnie wybrać „set” , aby wejść.
- » Za pomocą przycisków  oraz  zmienić wartość.
- » Nacisnąć przycisk „set”  lub „mode” , aby powrócić do poprzedniego menu.
*Uwaga: Jeśli termostat otrzymuje dane z kotła, wyświetla wówczas taką wartość.
W przeciwnym wypadku zakres ustawiania wynosi 30 – 60°C.*

5) Informacje o kotle (tylko kotły OpenTherm)

- » Za pomocą przycisków  oraz  wybrać informacje, a następnie wybrać „set” , aby wejść.
- » Kiedy wyświetla się „-- --”, oznacza to, że te dane nie są dostępne w kotle
- » Nacisnąć przycisk „set”  lub „mode” , aby powrócić do poprzedniego menu.

Nr	Informacje
1	Wartość zadana zasilania instalacji
2	Sonda przesyłu
3	Sonda powrotu
4	Temperatura c.w.u
5	Temperatura zewnętrzna
6	Procent mocy
7	Pobór ciepłej wody użytkowej
8	Ciśnienie instalacji

6) Ustawienia zaawansowane (PL)

» Parametry dla instalatora

- » Za pomocą przycisków \wedge \vee wybrać menu „PL”, a następnie „set” \leftarrow , aby wejść.
- » Przewinąć przyciskami \wedge \vee , do wartości „PS 10”, a następnie naciśnięć „set” \leftarrow . Wybrać parametr, który ma zostać zmieniony (patrz tabela poniżej), za pomocą przycisków \wedge \vee , a następnie naciśnięć „set” \leftarrow . Zmienić wybrany parametr za pomocą przycisków \wedge \vee , a następnie naciśnięć „set” \leftarrow , aby potwierdzić zmianę.
- » Naciśnięć „set” \leftarrow lub „mode” \equiv , aby powrócić do poprzedniego menu.

Param.	Opis	Stopniowo (Step)	Jednostka	Wartość domyślna	Zakres
CLL	Kalibracja czujnika otoczenia	0,1	°C	Temperatura otoczenia	-7,0 + 7,0 °C
FRCL	Resetowanie do ustawień fabrycznych		---	NIE	NIE - TAK
HON	Histeresa WŁ (*)	0,1	°C	0,4	0,0 ÷ 2,0
HOF	Histeresa WYŁ (*)	0,1	°C	0,1	0,0 ÷ 2,0
BLLE	Czas podświetlania wyświetlacza			08	03 ÷ 15
HHCH	Maks. nastawa przesylu (***)	1	°C	85	45 ÷ 85°C
LLCH	Min. nastawa przesylu (***)	1	°C	30	10 - HHCH
CLL	Krzywa klimatyczna (***)		---	1,2	0,0, 0,2, 0,4, 0,6, 0,8, 1,0, 1,2, 1,5, 2,0, 2,5, 3,0
HHBO	CH nastawy kotła (***)	1	°C	85°C	30 ÷ 85°C
EXIT	Exit				

(*) żądanie włącza się, gdy T. otocz. < Tset -HON

(**) żądanie wyłącza się, gdy T.otocz. > Tset + HOF

(***) tylko przy podłączeniu OpenTherm

7) Exit

» Naciśnąć „set” ←, aby powrócić do menu głównego.

5.8 Kompensacja przy użyciu temperatury zewnętrznej.

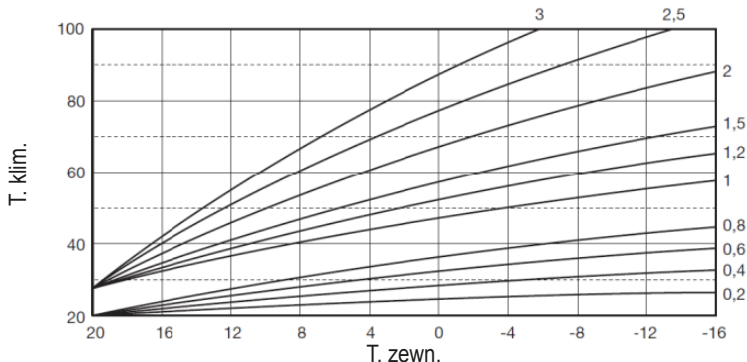

Dzięki temperaturze zewnętrznej (z Internetu lub podłączonej do kotła) termostat oblicza temperaturę kotła na zasilaniu instalacji, optymalizując zużycie. Przy użyciu parametru CLI (zob. menu instalatora PL), reguluje się pobór według wzoru:

$$\text{Tzasilania} = T \text{ klim} + 10 \times \text{CLI} \times (T3 - T4)$$

Aby wyłączyć czujnik zewnętrzny, należy ustawić CLI = 0, w takim przypadku otrzymujemy:

$$\text{Tzasilania} = \text{LLCH} + 10 \times (T3 - T4)$$

T3 = nastawa temp otoczenia





















T4 = temp otoczenia

T klim = zobacz wykres

LLCH = zob. menu instalatora PL

5.9 Odbiornik

Odbiornik pozwala na wymianę danych pomiędzy termostatem a kotłem.
Obecny jest przycisk z kolorowymi diodami led, które informują o stanie systemu.

Zielona DIODA	Czerwona DIODA	OPIS				
Powolne miganie	Powolne miganie					
WŁ	Powolne miganie					
WŁ	WYŁ					
Szybkie miganie	WYŁ				Trwa połączenie Wi-Fi	
WYŁ	Szybkie miganie				Trwa połączenie radiowe	

6. SPECYFIKACJE TECHNICZNE

Elektryczne / mechaniczne	Zasilanie	100 ~ 240 VAC, 50 / 60 Hz
	Zużycie	1,2 W
	Wyjścia przekaźników	Czysty styk - 0,25 A – 230 VAC, 2A - 30 VDC
	Termostat	90 x 90 x 22 mm
	Odbiornik	86 x 86 x 21 mm
	Kolor	Czarny + srebrny
	Materiał obudowy	ABS + aluminium
	Czujnik temperatury	Wbudowany
Wi-Fi	Standard Wi-Fi	802.11 b/g/n
	Częstotliwość Wi-Fi	2.412 GHz – 2.484 GHz
	Częstotliwość RF	868 MHz [FSK]
	Odległość RF	maks. 40 m w wolnej przestrzeni (*)
	Antena	wbudowana
	Bezpieczeństwo	WEP / WPA - PSK / WPA2 - PSK
	Protokół	IPv4, TCP
Typ sieci	STA	

() Ewentualne przeszkody lub ściany mogą ograniczać zasięg sygnału WiFi. W taki przypadku przybliżyć bramkę do routera lub skorzystać ze wzmacniacza WiFi.*

1.	Presentatie.....	200
2.	Algemene veiligheidsvoorschriften	200
3.	Regelingsklasse volgens de ErP-verordening.....	200
4.	Voor de installateur.....	201
4.1	Inhoud.....	201
4.2	Installatie van de ontvanger.....	202
4.3	Installatie van de thermostaat.....	204
4.4	Montage thermostaatsteun.....	205
5.	Voor de eindgebruiker	206
5.1	Knoppen en symbolen.....	206
5.2	Functieschema	208
5.3	Systeemconfiguratie	209
5.3.1	Aanmaken van een account.....	209
5.4	Configuratie RF (ontvanger - thermostaat).....	209
5.5	Wifi-configuratie (ontvanger - router).....	210
5.6	APP СОИИЕСТ	211
5.6.1	Handbedieningsmodus	214
5.6.2	Modus Weekprogramming.....	215
5.6.3	Vakantiemodus.....	219
5.6.4	Modus Thermostaat uit	219
5.7	Thermostaat.....	220
5.7.1	Basisbewerkingen	220
5.8	Compensatie met buitentemperatuur.	224
5.9	Ontvanger.....	225
6.	Technische specificaties.....	226

1. PRESENTATIE

Beste klant, wij bedanken u dat u gekozen heeft voor de slimme thermostaat CONNECT. Hiermee kunt u de omgevingstemperatuur nauwkeurig besturen, en dankzij de wifi-connectiviteit is bediening op afstand mogelijk via de speciale app.

Deze handleiding is bedoeld voor installateurs en eindgebruikers.

Het belangrijkste element van het systeem is de klokthermostaat die tijdsprogramma's kan beheren die zijn ingesteld met de app, de zonetemperatuur kan meten en opdrachten voor in- en uitschakeling kan verzenden naar een externe besturingseenheid die rechtstreeks verbonden is met de ketel.

2. ALGEMENE VEILIGHEIDSVORSCHRIFTEN

- Lees de instructies in deze handleiding aandachtig door.
- Leg de gebruiker na de installatie de functies van het toestel uit en geef hem dit boekje, dat zorgvuldig moet worden bewaard omdat het onderdeel is van het product en om het later nog te kunnen raadplegen
- De installatie en het onderhoud moeten worden verricht door ervaren, gekwalificeerd personeel volgens de geldende voorschriften en in overeenstemming met de instructies van de fabrikant. Voer geen handelingen uit op de verzegelde besturingsonderdelen.
- Schakel de elektrische voeding uit alvorens het apparaat te reinigen.
- Plaats het toestel niet in de buurt van warmtebronnen.
- Houd het buiten het bereik van kinderen

3. REGELINGSKLASSE VOLGENS DE ERP-VERORDENING

Onder verwijzing naar de gedelegeerde verordening (EU) Nr. 811/2013 kunnen de gegevens in de tabel worden gebruikt om de etikettering van verwarmingstoestellen te completeren. Mogelijke combinaties met CONNECT, de overeenkomende configuratieklassen en energiebijdragen aan het systeem.

Type ketel	CONNECT	Klasse en bijdrage
Ketel met vaste aanvoertemperatuur (On-Off)	Type On-Off	I = 1%
Ketel met variabele aanvoertemperatuur (setpoint met communicatiebus)	Verbinding via communicatiebus. Setpoint aanvoer berekend op grond van de omgevings- en buitentemperatuur.	VI = 4%
	Verbinding via communicatiebus. Setpoint aanvoer berekend op basis van minstens 3 verschillende omgevingstemperaturen (hiervoor zijn minstens 3 thermostaten en 3 zoneventielen nodig)	VIII = 5%

4. VOOR DE INSTALLATEUR

4.1 Inhoud

De doos bevat de volgende onderdelen:



Zender
klokthermostaat



Ontvanger



Handleiding



USB-kabel



Voedingsapparaat

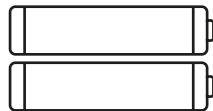

Batterijen type AAA



Tafelsteun

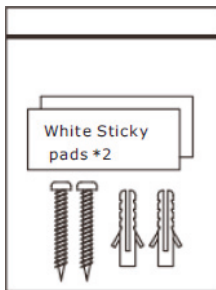

Accessoires

4.2 Installatie van de ontvanger

LET OP: schakel de voeding van de ketel uit voordat de verbinding wordt gemaakt, om het toestel te beschermen. Dit moet worden gedaan door ervaren personeel.

De ontvanger kan werken met het OpenTherm-protocol of met het On-Off-contact. Gebruik de magnetische plaat of de tweezijdige kleefstrook, die bij de accessoires is meegeleverd, om de ontvanger in de beste positie te zetten gezien de kwaliteit van het oppervlak. of gebruik schroeven om hem rechtstreeks aan de muur vast te zetten.

De gateway moet in het gebouw worden gemonteerd en mag niet worden afgeschermd door eventuele metalen omhulsels.

Optie OpenTherm (A afb. 1): Verbind de twee rode draden met het label **OTBus**, afkomstig van de ontvanger, met de ketel waarop de **OpenTherm**-verbinding moet worden gemaakt. Laat de andere twee draden losgekoppeld. In dit geval is er meer informatie beschikbaar over de status van de ketel (zie “5.7.1 Basisbewerkingen” op pag. 220).

Optie On-Off (B afb. 1): Verbind de twee zwarte draden met het label **ON/OFF**, afkomstig van de ontvanger, met de ketel waarop de verbinding met de **ON/OFF**-thermostaat moet worden gemaakt. Laat de andere twee draden losgekoppeld.

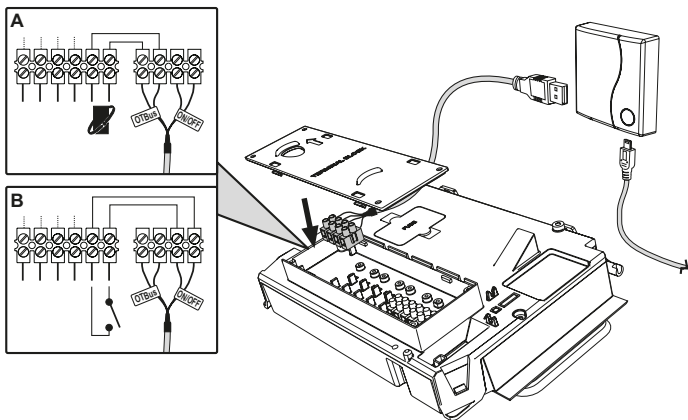

afb. 1

Wanneer ze worden gevoed, knipperen de leds eventjes.

4.3 Installatie van de thermostaat

Maak COMECT los van de basis afb. 2.

Zet de basis vast met de meegeleverde schroeven afb. 3.

Als de thermostaat direct verbonden is met de ketel of met een zoneventiel, moeten de kabels worden aangesloten in de desbetreffende klem afb. 4.

Plaats 2 batterijen van 1,5V type AAA afb. 5.

Bevestig COMECT op de basis afb. 6.

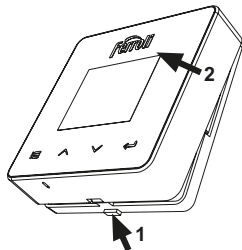

afb. 2

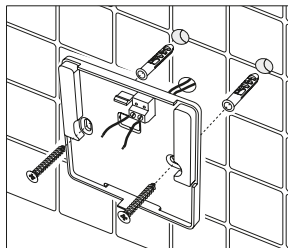

afb. 3

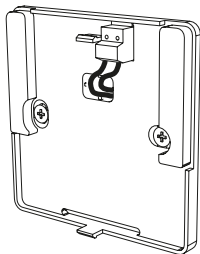

afb. 4

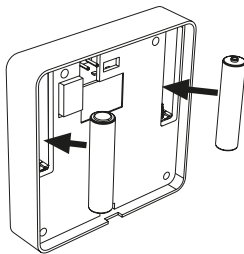

afb. 5

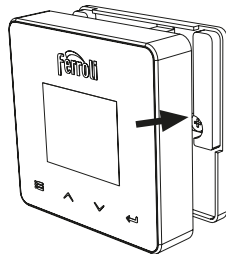

afb. 6

4.4 Montage thermostaatsteun

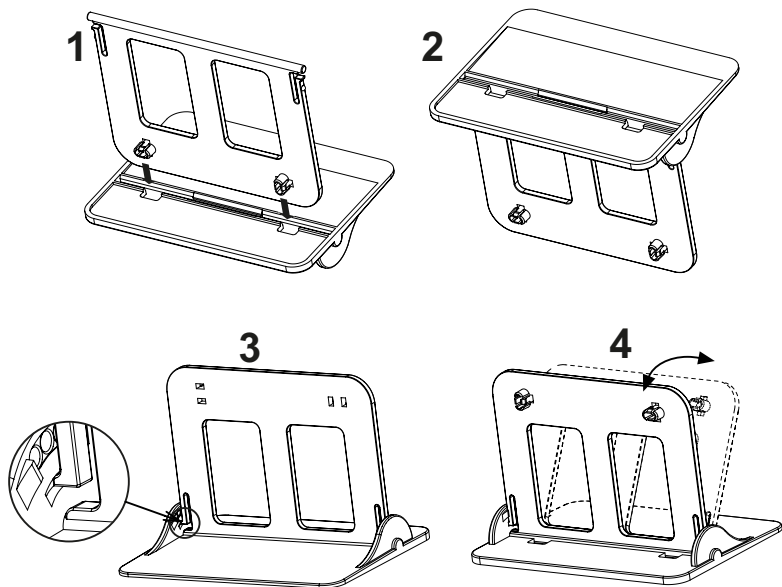

afb. 7 - Thermostaatsteun

5. VOOR DE EINDGEBRUIKER

5.1 Knoppen en symbolen

Hieronder vindt u een beschrijving van de symbolen op het display en de betekenis van de knoppen.

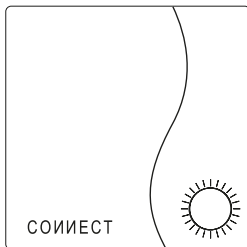

afb. 8

Symbol	Beschrijving
	Verwarming
	Sanitair water
	Warmtevraag
	OFF
	AUTO-modus
	HANDBEDIENING-modus
	VAKANTIE-modus

Symbol	Beschrijving
	RF-verbinding
	WiFi-verbinding
	Batterijniveau laag
	Temperatuur en tijd
	Modus/opslaan/sluiten
	Verhogen
	Verlagen
	Instellen
	Led-toets

Batterij: Als de batterijlading onvoldoende is, verschijnt het symbool op het scherm.

Vlam

- » Thermostaat verbonden met een on-off-ketel, het symbool geeft de staat van de vraag aan.
- » Thermostaat verbonden met een OpenTherm-ketel, het symbool geeft de staat van de brander aan.

Opmerkingen: bij de eerste inschakeling wordt de thermostaat automatisch geconfigureerd in de verbindingsmodus met draad, **On-Off**.

Als de thermostaat en de wifi-ontvanger draadloos zijn verbonden schakelt de thermostaat automatisch over naar de modus **RF On-Off**.

Als de wifi-ontvanger verbonden is met een OpenTherm-ketel, schakelt de thermostaat automatisch over naar de modus **RF OpenTherm**.

Als de thermostaat geconfigureerd is als RF (on-off of OpenTherm) schakelt hij niet automatisch over naar de modus **draad On-Off**. Dit kan alleen worden gedaan door de batterijen te verwijderen en terug te plaatsen.

Sanitair: het pictogram geeft aan dat het sanitaire water actief is.

Opmerkingen: het symbool is alleen aanwezig bij een RF-verbinding met OpenTherm-ketels.

Verwarming: het symbool geeft aan dat de verwarming actief is.

Opmerkingen: het symbool is alleen aanwezig bij een RF-verbinding met OpenTherm-ketels.

Temperatuur: de omgevingstemperatuur of de fouten worden weergegeven:

E82: RF-communicatiefout

E83: OpenTherm-communicatiefout

5.2 Functieschema

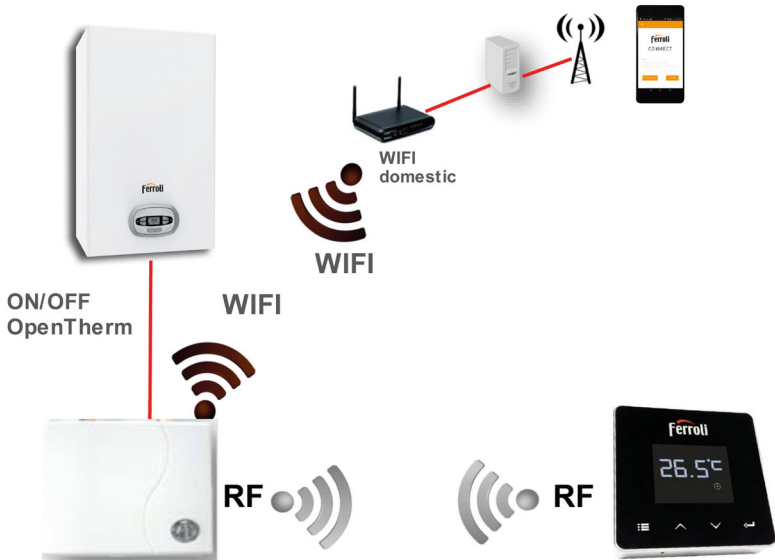

afb. 9

5.3 Systeemconfiguratie

Om een goede werking vanaf een apparaat (tablet of smartphone) mogelijk te maken, zijn de volgende stappen nodig:

- Download de app (CONNECT) rechtstreeks uit de App Store van uw apparaat of met de QR CODE op de buitenkant van de verpakking.
- Maak na de installatie een account aan.





5.3.1 Aanmaken van een account

- Controleer of uw SMARTPHONE/TABLET verbonden is met het wifi-netwerk.
- Open de speciale app en klik op “Registreren”.
- Voer de gevraagde gegevens in en druk op Code verifiëren.
- Om de registratie te bevestigen, voer de code in die u ontvangt op het e-mailadres dat u eerder heeft ingevoerd.

Om de ketel vanaf meerdere apparaten te gebruiken, is toegang nodig met dezelfde account.

5.4 Configuratie RF (ontvanger - thermostaat)

Volg de onderstaande stappen om de RF-verbinding tussen thermostaat en ontvanger te maken:

- Druk op de led-toets van de ontvanger totdat deze knippert (ongeveer 7 seconden).
- Houd in de thermostaat de toets “instellen”  een paar seconden ingedrukt, totdat het display knippert.
- Druk op de toets  totdat **COUP** verschijnt en druk op de toets “instellen” .
- Wanneer het bericht “r01, r02..÷..r08” verschijnt, is de verbinding tot stand gekomen. Druk opnieuw op de toets “instellen” .

Opmerking: de gegevensuitwisseling tussen thermostaat en ontvanger vindt plaats binnen 2 minuten

5.5 Wifi-configuratie (ontvanger - router)

Maak de verbinding tussen uw smartphone / tablet en het lokale wifi-netwerk.

- Klik op “+” en voer het wachtwoord van het lokale netwerk in
- Druk op “vooruit” ⊖.
- Druk in de ontvanger even op de knop WPS met een geschikt instrument
- Druk op “vooruit” ⊖.
- Volg de instructies van de app

Als de procedure niet met succes is afgerond:

- Controleer de wifi-verbinding van het mobiele apparaat (de configuratie moet gebeuren met wifi)
- Controleer de router, herstart het mobiele apparaat en herhaal de handelingen

5.6 APP CONNECT

Druk op de aangegeven plaats op het hoofdscherm (afb. 10), om toegang te krijgen tot de controle van een van de geconfigureerde ketels.

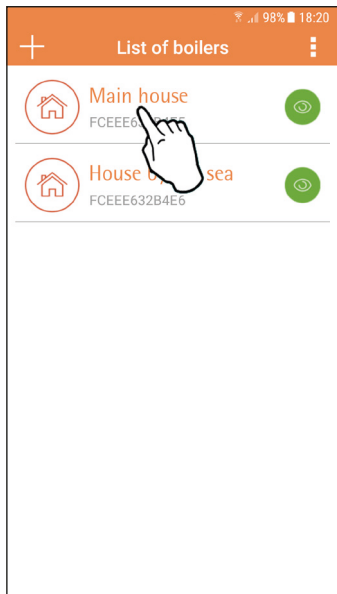

afb. 10 - Hoofdscherm

Druk in het volgende scherm (afb. 11) op **A** om de temperatuur in de ruimte te regelen of druk op **B** om de staat van de ketel te zien.

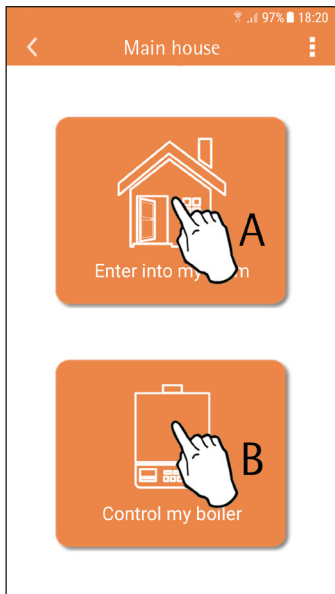

afb. 11 -





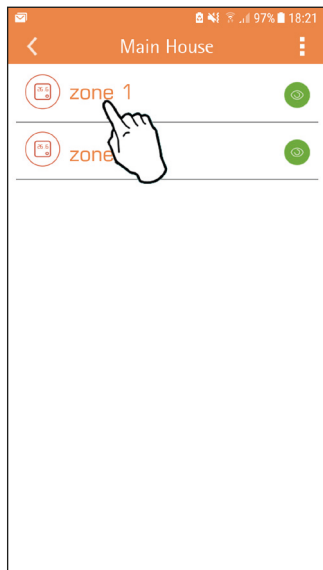

Vanuit dit scherm is toegang mogelijk tot de instelling van de verbonden externe klokthermostaat.

Als er meerdere zones zijn, selecteert u de gewenste zone.



afb. 12 - Besturing klokthermostaat

De mogelijke werkwijzen zijn:

-  Handbedieningsmodus
-  Weekprogrammering
-  Vakantiemodus
-  Thermostaat uit



afb. 13 - Mogelijke werkwijzen



Als de ketel verbonden is via het OpenTherm-protocol, kan in dit scherm (afb. 14) de staat ervan worden bekeken. Door op de symbolen  te klikken is het bovendien mogelijk om de setpoints van het sanitaire water en de verwarming in de ketel te veranderen.

Als de ketel verbonden is via het On-Off-contact, wordt alleen de staat van de vraag weergegeven (afb. 15).

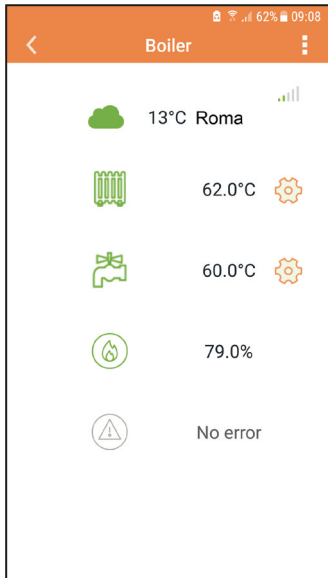

afb. 14 - Met OpenTherm

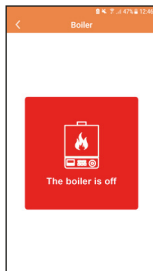
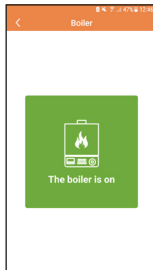

afb. 15 Met omgevingsthermostaat



5.6.1 Handbedieningsmodus

In deze modus kan de gewenste omgevingstemperatuur worden ingesteld.

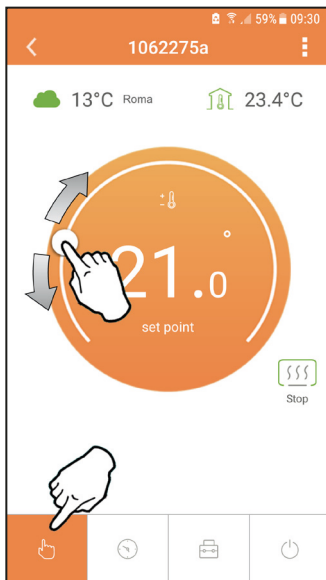

afb. 16

5.6.2 Modus Weekprogramming

In deze modus kan de gewenste temperatuur worden ingesteld in de verschillende tijdvakken van alle dagen van de week door op het punt “B” te drukken dat is aangegeven in afb. 17.

Bovendien is het mogelijk om de gewenste temperatuur tijdelijk te veranderen (tot het volgende tijdvak) door op punt “A” te drukken, zonder het programma te wijzigen.

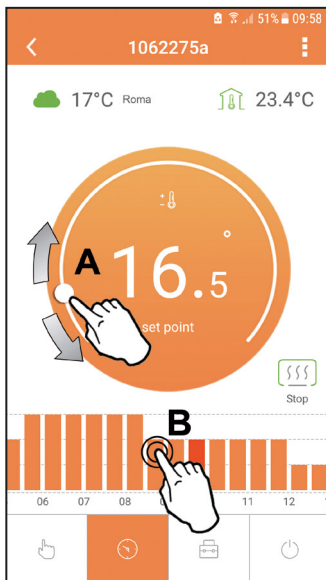

afb. 17

Er staan 3 temperaturniveaus ter beschikking: **T3** (niveau COMFORT 1), **T2** (niveau COMFORT 2) en **T1** (niveau ECO).

Om de temperatuur van niveau **T1**, **T2** en **T3** in te stellen volgt u de onderstaande sequens.

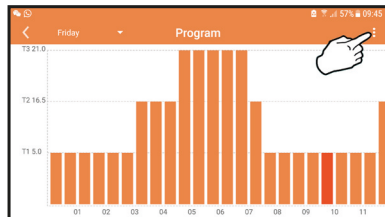

afb. 18

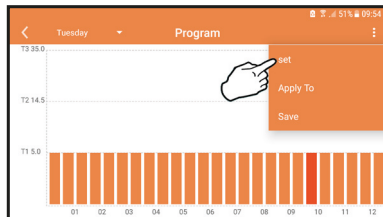

afb. 19

Stel de temperaturen in en bevestig.

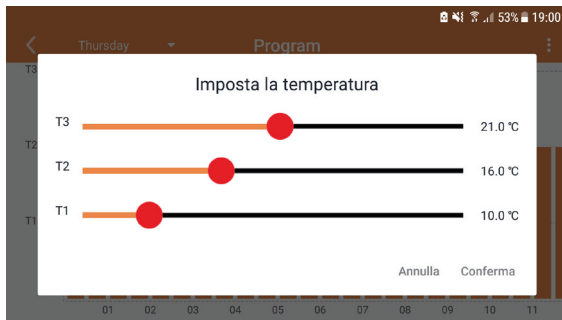

afb. 20 Instelling temperaturen

Om de tijdvakken te veranderen, drukt u in het gebied dat u wilt wijzigen.

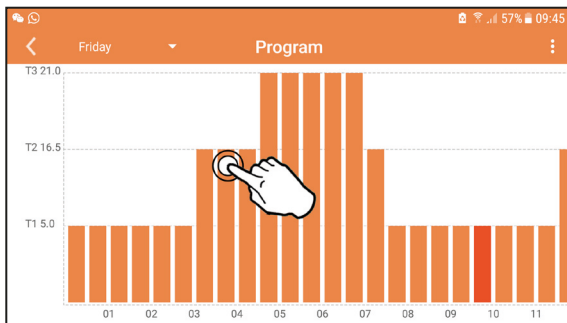

afb. 21

Sla de configuratie op, nadat de temperaturen zijn geprogrammeerd.

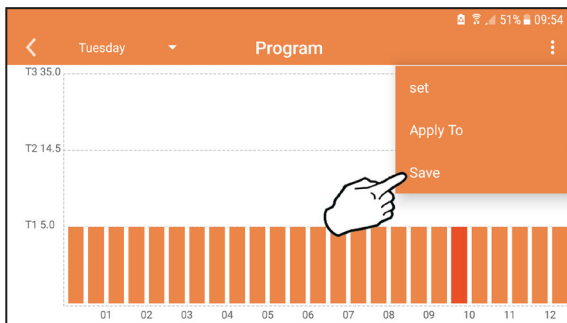

afb. 22

Klik op “toepassen” om de dagen te kiezen waarop de zojuist gemaakte instellingen moeten worden gekopieerd.

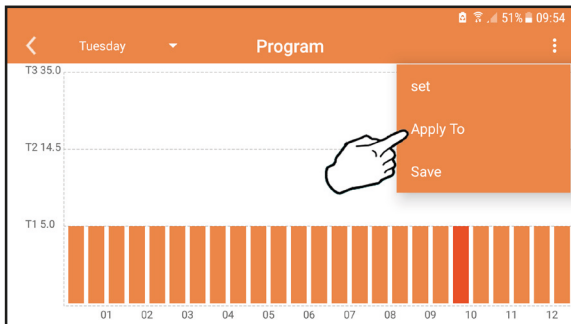

afb. 23

Als de informatie omtrent de buitentemperatuur beschikbaar is (via het web of OpenTherm), houdt de ingestelde temperatuur in de ketel rekening met deze waarde om de aanvoer te regelen.

Als de buitentemperatuur niet beschikbaar is, wordt de aanvoer geregeld op de ingestelde omgevingstemperatuur.

5.6.3 Vakantiemodus

In deze modus wordt de ketel uitgeschakeld en weer geactiveerd wanneer de temperatuur onder het aangegeven setpoint daalt.

Door op het instellingssymbool  te drukken kan de einddatum van de vakantie worden ingesteld.

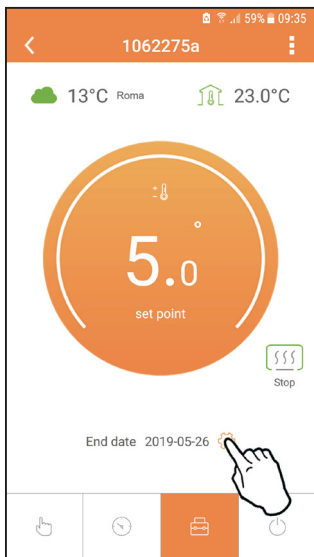

afb. 24

5.6.4 Modus Thermostaat uit



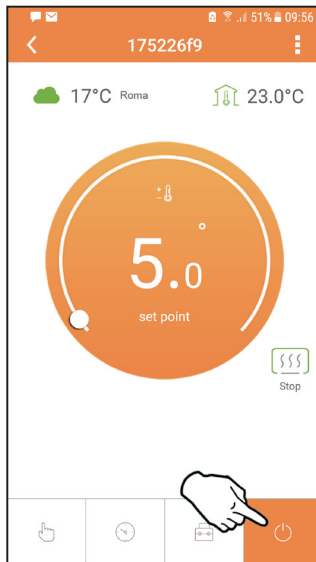











In deze modus wordt de ketel uitgeschakeld en weer geactiveerd wanneer de temperatuur onder 5°C daalt.



afb. 25

5.7 Thermostaat







5.7.1 Basisbewerkingen

1. Door op de toets “mode”  te drukken wordt afgewisseld tussen de verschillende modi:
 - a. **Off** : in deze modus is de warmtevraag uitgeschakeld, alleen de antivriesfunctie blijft actief.
 - b. **Vakantie** : de ingestelde temperatuur is die van de antivries-energiebesparing voor een aantal dagen dat is ingesteld met de toetsen  .
 - c. **Automatisch** : de gevraagde temperatuur is die van het weekprogramma dat is ingesteld met de app. Als het programma niet is ingesteld, wordt het standaardprogramma van het systeem gebruikt.
 - d. **Handbediening** : de temperatuur wordt handmatig ingesteld, rechtstreeks op de thermostaat.
2. **Temperatuur instellen:**
 - a. **Handbediening:** gebruik de toetsen  .
3. **Menu Instellingen:** door de toets “instellen”  ongeveer 2 seconden ingedrukt te houden wordt het menu Instellingen geopend.
 - a. “ en  de geselecteerde parameter wordt geopend
 - c. “modus”  voor terugkeer naar het hoofdmenu
4. Bij een storing in de ketel wordt de foutcode ook weergegeven op het display van de thermostaat. De storing kan worden ontgrendeld met de toets “instellen” .







Voor een beschrijving van de storing, zie het boekje van de ketel.

Nr.	Parameter	Display	Beschrijving
1)	Klok	14:05	Voor instelling van de uren, minuten, jaar (y), maand (m), dag (d).
2)	Temperatuur	23.0°C ■	Stelt de temperatuur van CFT1, CFT2, ECO, FRST in
3)	COUP-code	COUP	RF-code (zie paragraaf 5.4 op pagina 209)
4)	Setpoint sanitair water	dHwJ ☰	Voor instelling van de temperatuur van het sanitaire water. Deze functie is alleen beschikbaar bij een OpenTherm-verbinding
5)	Ketelgegevens	1 nFO	Uitlezing van enkele ketelparameters, alleen met OpenTherm-verbinding
6)	Installeurgegevens	PL	Parameters voor installateur
7)	Sluiten	EXIT	Terug naar de beginpagina

1) Klok

- » Druk op de knoppen  en  om het klokmenu te selecteren, en daarna “instellen”  om het te openen.
- » Door op de toets “instellen”  te drukken wordt de datum geselecteerd die veranderd moet worden, in deze volgorde: 13:00 uren, 13:42 minuten, 19 4 jaar, 02 n maand, 21 d dag.
- » Druk op de knoppen  en  om de waarde te veranderen.
- » Druk op “modus”  om terug te keren.







2) Temperatuur

- » Druk op de knoppen  en  om het temperatuurmenu te selecteren, en daarna op “instellen”  om het te openen.
- » Druk op de knoppen  en  om de temperaturen te selecteren die veranderd moeten worden:
- » **comfort** (CFE) – **economy** (EEQ) – **antivries** (FR E)
- » Druk op de knoppen  en  om de waarde van de gekozen temperatuur te veranderen.
- » Druk op “instellen”  of “modus”  om terug te gaan naar het voorgaande menu.

3) Koppelingscode





» Zie paragraaf 5.4 op pagina 209.

4) Temperaturen sanitair water (alleen OpenTherm-ketels)

- » Druk op de knoppen   om het temperatuurmenu van het sanitaire water te selecteren, en daarna “instellen”  om het te openen.
- » Druk op de knoppen   om de waarde te veranderen.
- » Druk op “instellen”  of “modus”  om terug te gaan naar het voorgaande menu.

Opmerking: als de thermostaat het gegeven ontvangt van de ketel, geeft hij deze waarde weer, anders is het instellingsbereik 30 – 60°C.















5) Informatie van de ketel (alleen OpenTherm-ketels)

- » Druk op de knoppen   om gegevens te selecteren, en daarna op “instellen” om ze te openen.
- » Wanneer “- - -” wordt weergegeven, is de datum niet beschikbaar in de boiler
- » Druk op “instellen”  of “modus”  om terug te gaan naar het voorgaande menu.

Nr.	Informatie
1	Setpoint toevoer
2	Aanvoersonde
3	Retoursonde
4	Temperatuur sanitair water
5	Buitentemperatuur
6	Vermogenspercentage
7	Opname sanitair water
8	Druk installatie

6) Geavanceerde instellingen (PL)

» *Parameters voor installateur*

- » Druk op de knoppen   om het “PL” menu te selecteren, en daarna op “set”  om het te openen.
- » Scrol met de toetsen   naar de waarde “PS 10” en druk dan op “set” . Selecteer de parameter die gewijzigd moet worden (zie onderstaande tabel) met behulp van de toetsen   en druk op “set” . Wijzig de gekozen parameter met de toetsen   en druk daarna op “set”  om de wijziging te bevestigen.
- » Druk op “set”  of “mode”  om terug te keren naar het voorgaande menu.

Param	Beschrijving	Stap	Eenheid	Standaardwaarde	Bereik
CRU	Kalibratie omgevingsensor	0.1	°C	Ruimtetemperatuur	-7.0 + 7.0 °C
FRCE	Fabrieksreset		---	NEE	NEE - JA
HON	Hysteresis ON (*)	0.1	°C	0.4	0.0 ÷ 2.0
HOF	Hysteresis OFF (**)	0.1	°C	0.1	0.0 ÷ 2.0
BLLE	Duur displayverlichting			08	03 ÷ 15
HHCH	Max. setpoint toevoer (***)	1	°C	85	45 ÷ 85°C
LLCH	Min. setpoint toevoer (***)	1	°C	30	10 - HHCH
CLL	CH setpoint ketel (***)		---	1.2	0.0, 0.2, 0.4, 0.6, 0.8, 1.0, 1.2, 1.5, 2.0, 2.5, 3.0
HHBO	Max. verwarming (***)	1	°C	85°C	30 ÷ 85°C
EXIT	Exit				

(*) de vraag wordt geactiveerd als $T. omg < Tset - HON$

(**) de vraag wordt opgeheven als $T. omg > Tset + HOF$

(***) alleen met OpenTherm-verbinding

7) Exit

» Druk op “instellen”  om terug te gaan naar het hoofdmenu.

5.8 Compensatie met buitentemperatuur.

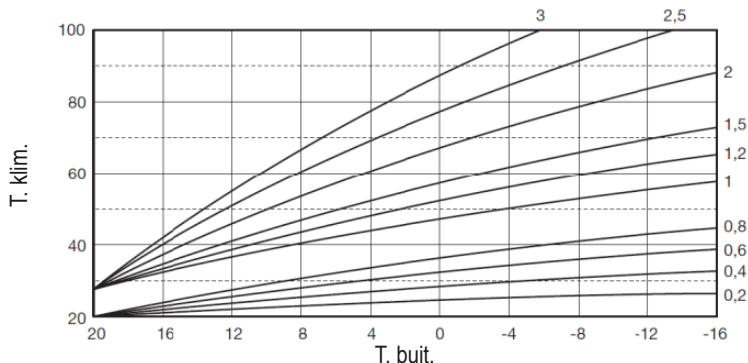

Aan de hand van de buitentemperatuur (van het web, of verbonden met de ketel) berekent de thermostaat de toevoertemperatuur van de ketel om het verbruik te optimaliseren. Door middel van de parameter CLI (zie het installateurmenu PL) wordt de bijdrage geregeld volgens de formule:

$$\text{Toevoer} = T_{\text{klim}} + 10 \times \text{CLI} \times (T_3 - T_4)$$

Om de buitensonde uit te schakelen, stelt u CLI = 0 in, in dat geval krijgt u:

$$\text{Toevoer} = \text{LLCH} + 10 \times (T_3 - T_4)$$

T₃ = setpoint omgeving





















T₄ = omgevingstemp

T_{clim} = grafiekwaarde

LLCH = zie installateurmenu PL

5.9 Ontvanger

De ontvanger maakt gegevensuitwisseling mogelijk tussen thermostaat en ketel. Hij heeft een knop met gekleurde leds die de staat van het systeem aanduiden.

Groene LED	Rode LED	OMSCHRIJVING				
Langzaam knipperende	Langzaam knipperende					
ON	Langzaam knipperende					
ON	OFF					
Snel knipperende	OFF				WiFi-verbinding	
OFF	Snel knipperende				RF-verbinding.	

6. TECHNISCHE SPECIFICATIES

Elektrisch/ mechanisch	Voeding	100 ~ 240Vac, 50 / 60 Hz
	Verbruik	1,2W
	Relaisuitgang	Potentiaalvrij contact - 0,25A – 230Vac, 2A - 30Vdc
	Thermostaat	90 x 90 x 22 mm
	Ontvanger	86 x 86 x 21 mm
	Kleur	Zwart + zilver
	Materiaal behuizing	ABS + aluminium
Temperatuursensor	ingebouwd	
Wifi	Standaard wifi	802.11 b/g/n
	Wifi-frequentie	2.412 GHz – 2.484 GHz
	RF-frequentie	868 MHz [FSK]
	Afstand RF	max. 40 m in open veld (*)
	Antenne	ingebouwd
	Beveiliging	WEP / WPA - PSK / WPA2 - PSK
	Protocol	IPv4, TCP
Type netwerk	STA	

() Eventuele obstakels of muren kunnen de reikwijdte van het wifi-sigitaal beperken. In dat geval moet de gateway dichterbij de router worden geplaatst of moet een wifi-extender worden gebruikt.*

The logo features the word "ferroli" in a bold, lowercase, sans-serif font. A grey, curved graphic element arches over the top of the letters "e" and "r".

ferroli

FERROLI S.p.A.

Via Ritonda 78/a

37047 San Bonifacio - Verona - ITALY

www.ferroli.com

Fabbricato in Cina - Made in China - Fabricado en China
Fabriqué en Chine - Fabricat în China - Сделано в Китае
Wyprodukowano w Chinach - Vervaardigd in China